

Service Service Service

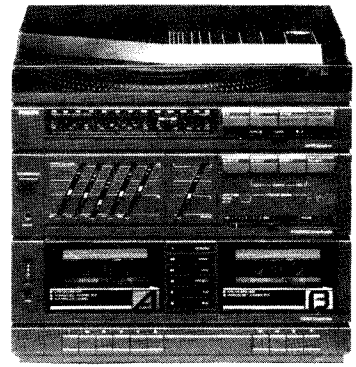

For Servicing Information concerning the cassette mechanism refer to Service Manuals: "Tape transport RT-74, Tape transport RT-76".

For Servicing Information concerning the record player refer to Service Manual P284.

38 545 A12

Service Manual

GB

TECHNICAL DATA

Power supply voltages

Power consumption

Dimensions

Wave ranges

FM
MW
LW

Sensitivity

 Δf 75 kHz FM

600 kHz AM

IF: FM

IF: AM

Aerial input

Output power (at 4 Ω load)

Output impedance

Output impedance of headphones

Cassette deck

Speed

Wow and flutter

Record player

Speed

Wow and flutter

NL

SPECIFICATIES

Voedingsspanningen

Opgenomen vermogen

Afmetingen

Golfbereiken

FM
MW
LW

Gevoeligheid:

 Δf 75 kHz FM

600 kHz AM

IF: FM

IF: AM

Antenne ingang

Uitgangsvermogen (4 Ω)

Uitgangsimpedantie

Uitgangsimpedantie hoofdtelefoon

Recorder

Snelheid

Wow en flutter

Platenspeler

Snelheid

Wow en flutter

F

SPECIFICATIONS

Alimentation

Puissance absorbée

Dimensions

Gammes d'ondes

FM
PO
GO

Sensibilité

 Δf 75 kHz FM

600 kHz AM

IF: AM

IF: AM

Impédance d'antenne

Puissance de sortie (4 Ω)

Impédance de sortie

Impédance de sortie écouteurs

Magnétophone

Vitesse

Pleurage et scintillement

Tourne-disque

Vitesse

Pleurage et scintillement

D

TECHNISCHE DATEN

Versorgungsspannungen

Leistungsaufnahme

Abmessungen

Wellenbereiche:

UKW
FM
MW

Empfindlichkeit:

 Δf 75 kHz FM

600 kHz AM

IF: FM

IF: AM

Antennen-Impedanz

Ausgangsleistung (4 Ω)

Ausgangsimpedanz

Kopfhörer-Ausgangs impedanz

Recorder

Geschwindigkeit

Gleichlaufschwankungen

Plattenspieler

Geschwindigkeit

Gleichlaufschwankungen

I

DATI TECNICI

Tensioni d'alimentazione : 220 V (110, 127, 240 V Service solution) 50/60 Hz~

Potenza assorbita : \leq 55 W

Dimensioni

Gamme d'onda

FM
OM
OL

Sensibilità:

 Δf 75 kHz FM

600 kHz AM

IF: FM

IF: AM

Ingresso antenna

Potenza d'uscita (con carico 4 Ω)

Impedenza d'uscita

Impedenza d'uscita per cuffia

Piastra registratore

Velocità

Wow e flutter

Giradischi

Velocità

Wow e flutter

: 87.5 - 108 MHz (2000-1177 m)

: 520 - 1605 kHz (577-187 m)

: 150 - 255 kHz

: (3 μ V mono, 26 dB SN): (90 μ V stereo, 46 dB SN): (1200 μ V/m for 26 dB SN)

: 10.7 MHz

: 450 kHz

: 300 Ω : 2 x 7.5 W (1 kHz) $D \leq$ 10%: 4 Ω : 4-1000 Ω : 4.76 cm/sec \pm 0.5%: \leq 0.2%

: 331/3-45 r.p.m.

: \leq 0.3%

GB

NL

Subject to modification

4822 725 20745

F

D

I

PHILIPS

Published by
Service Consumer Electronics

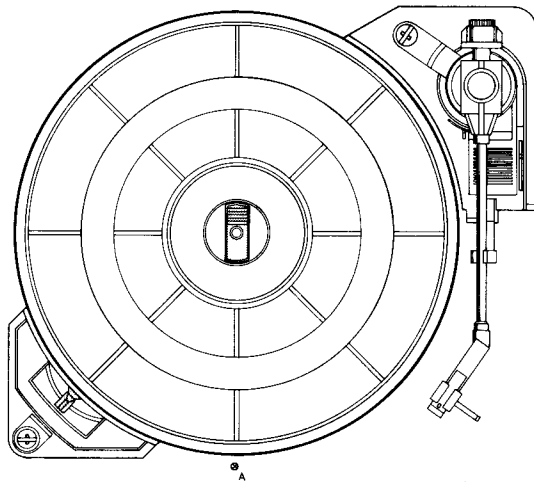
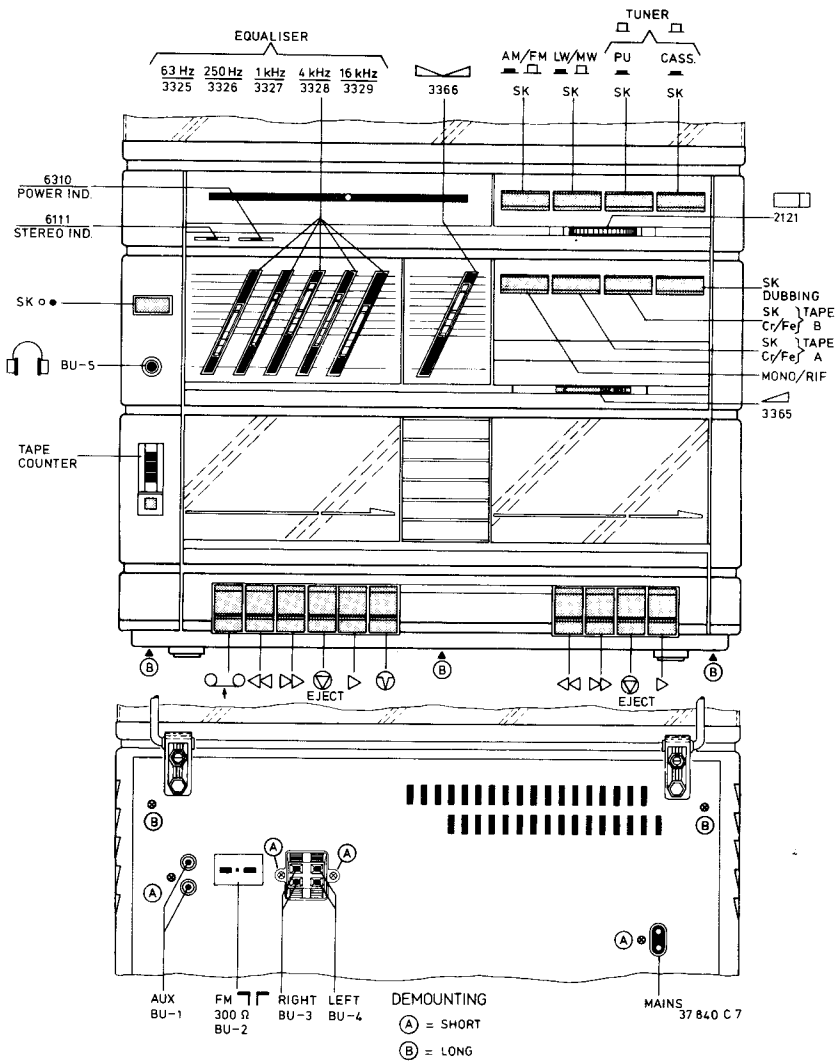

GB

Safety regulations require that the set be restored to its original condition and that parts which are identical with those specified be used.

NL

Veiligheidsbepalingen vereisen, dat het apparaat in zijn oorspronkelijke toestand wordt teruggebracht en dat onderdelen, identiek aan de gespecificeerde, worden toegepast.

F

Les normes de sécurité exigent que l'appareil soit remis à l'état d'origine et que soient utilisés les pièces de rechange identiques à celles spécifiées.

D

Bei jeder Reparatur sind die geltenden Sicherheitsvorschriften zu beachten. Der Originalzustand des Geräts darf nicht verändert werden. für Reparaturen sind Original-Ersatzteile zu verwenden.

I

Le norme di sicurezza esigono che l'apparecchio venga rimesso nelle condizioni originali e che siano utilizzati i pezzi di ricambio identici a quelli specificati.

2101	A 2	2109	B 4	2114	A 8	2120	D 3	2123	D 4	2132	F 6	2137	H 9	2142	H 8	2153	B 16	2158	B 20	2163	F 15	2175	D 17	2180	G 20	3106	B 6	3111	C 6	3126	G 8	3134	D 12	3139	B 10	3146
2102	A 3	2110	B 4	2115	C 8	2121	B 4	2124	D 5	2133	F 6	2138	H 10	2143	O 13	2154	B 16	2159	B 21	2164	E 15	2176	D 16	2190	K 16	3107	B 7	3116	D 2	3130	B 9	3135	B 13	3141	G 14	3147
2103	B 3	2111	B 5	2116	C 5	2121	E 6	2125	E 5	2134	H 8	2139	H 10	2150	B 10	2155	B 17	2160	B 21	2165	A 17	2177	G 20	2191	K 15	3108	A 8	3119	D 4	3131	B 9	3136	B 16	3142	F 15	3155
2105	B 3	2112	B 6	2117	B 8	2121	H 7	2126	E 5	2135	H 7	2140	H 9	2151	D 12	2156	A 16	2161	F 14	2173	D 18	2178	H 20	2404	E 3	3109	C 5	3120	D 5	3132	C 11	3137	B 17	3143	F 15	3155
2107	B 5	2113	B 7	2119	E 2	2121	H 9	2128	E 5	2136	H 9	2141	G 12	2152	B 15	2157	B 20	2162	G 14	2174	H 16	2179	G 20	3103	A 3	3110	C 5	3121	E 4	3133	D 11	3138	B 17	3145	B 19	3157

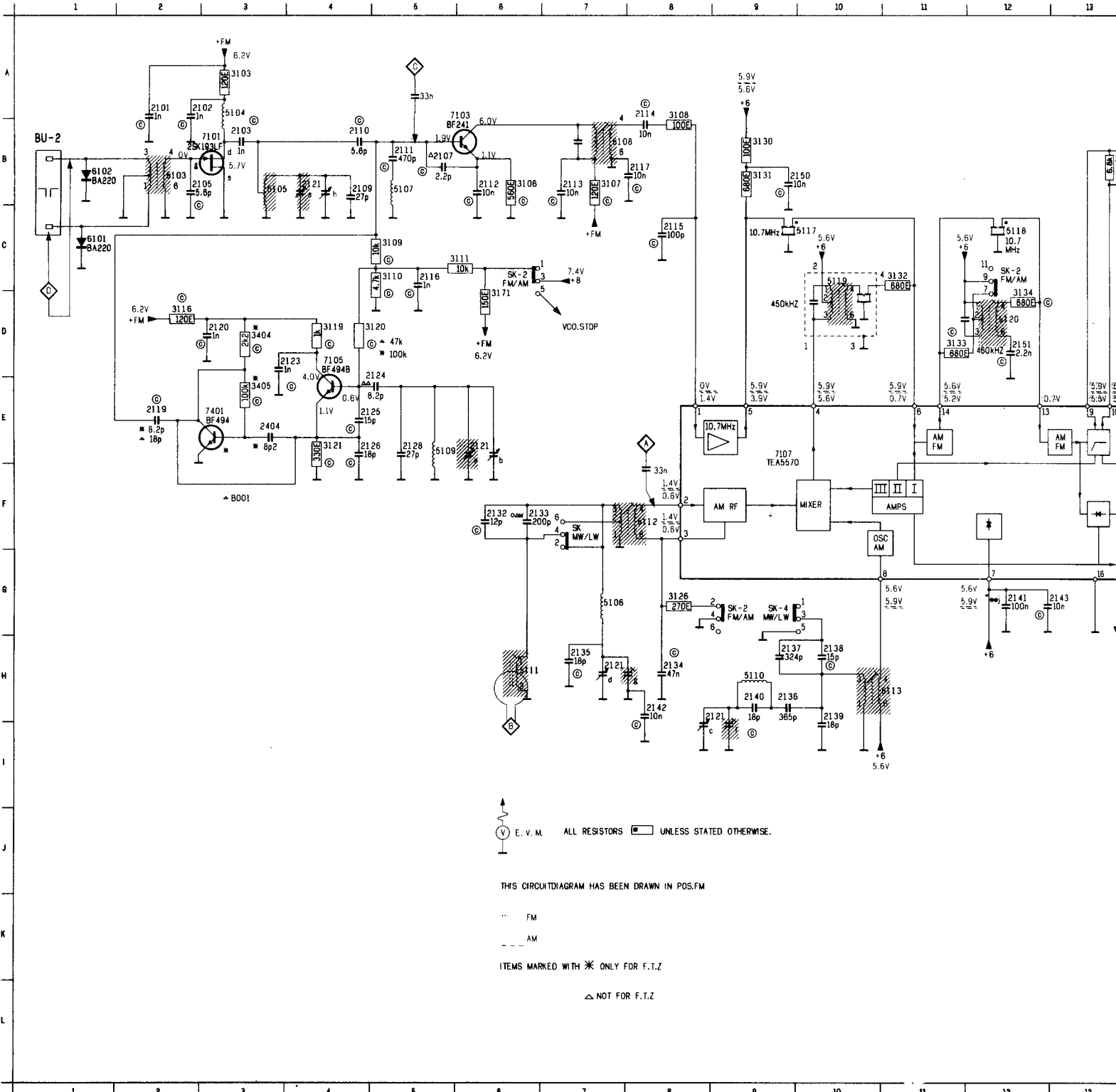

B 6 3111 C 6 3126 G 8 3134 D12 3139 B18 3146 B20 3158 E18 3164 G21 3405 E 3 5107 B 5 5112 F 8 5120 D12 6102 B 1 7101 B 3 7109 B19
 B 7 3116 D 2 3130 B 9 3135 B13 3141 G14 3147 R20 3159 E17 3170 J17 5103 B 2 5108 B 7 5113 H11 5121 B14 6106 B16 7103 B 6 7401 E 3
 B 8 3119 D 4 3131 B 9 3136 B16 3142 F15 3155 H17 3161 G20 3171 D 6 5104 B 3 5109 E 5 5117 C10 5122 B15 6107 B16 7105 D 4
 C 5 3120 D 5 3132 C11 3137 B17 3143 F15 3156 H18 3162 H20 3172 K16 5105 B 3 5110 H 9 5118 C12 5123 R20 6109 K17 7107 E 9
 C 5 3121 E 4 3133 D11 3138 B17 3145 B19 3157 E18 3163 G21 3404 D 3 5106 G 7 5111 H 6 5119 C10 6101 C 1 6111 H18 7108 F16

10 11 12 13 14 15 16 17 18 19 20 21 22

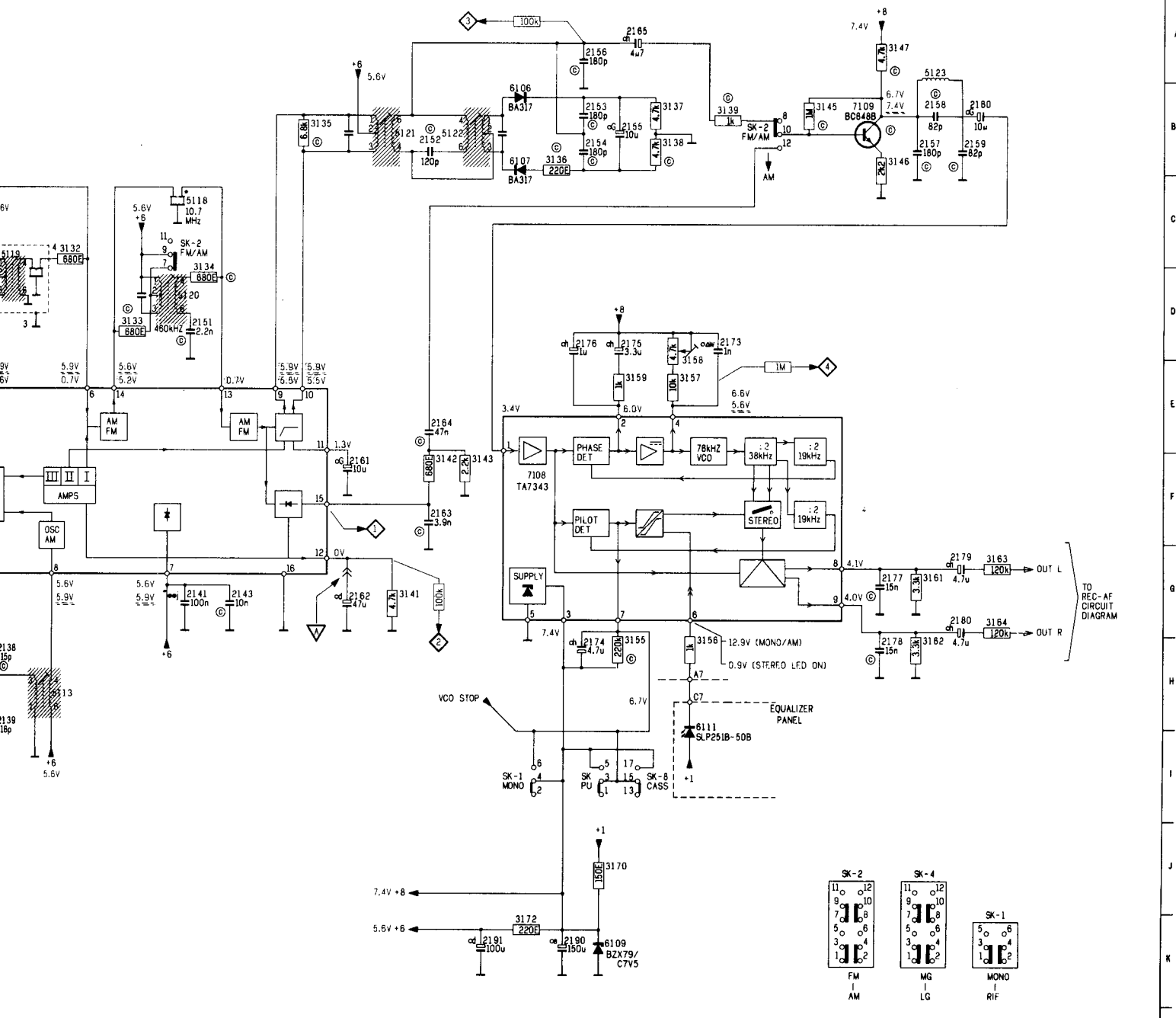

ALL SWITCHES DRAWN IN REST-POSITION

RF PART
 PRS. 00482

10 11 12 13 14 15 16 17 18 19 20 21 22

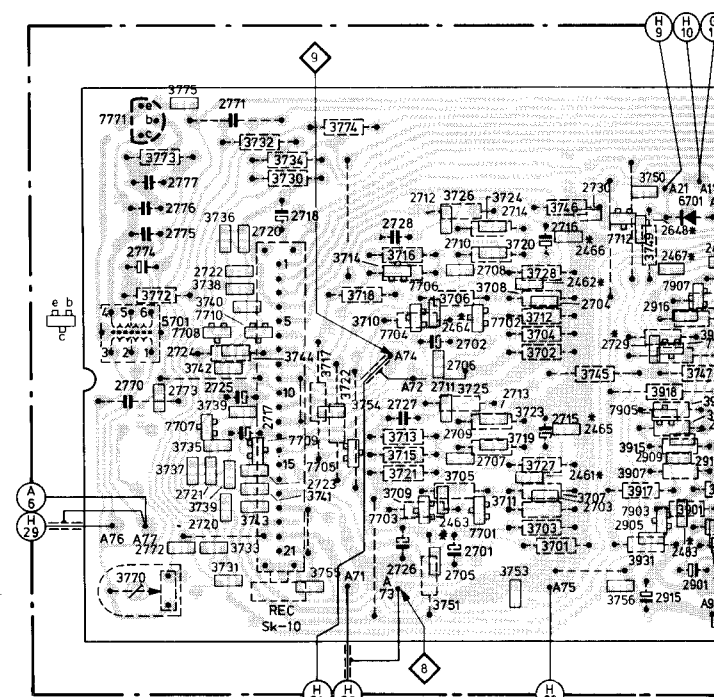
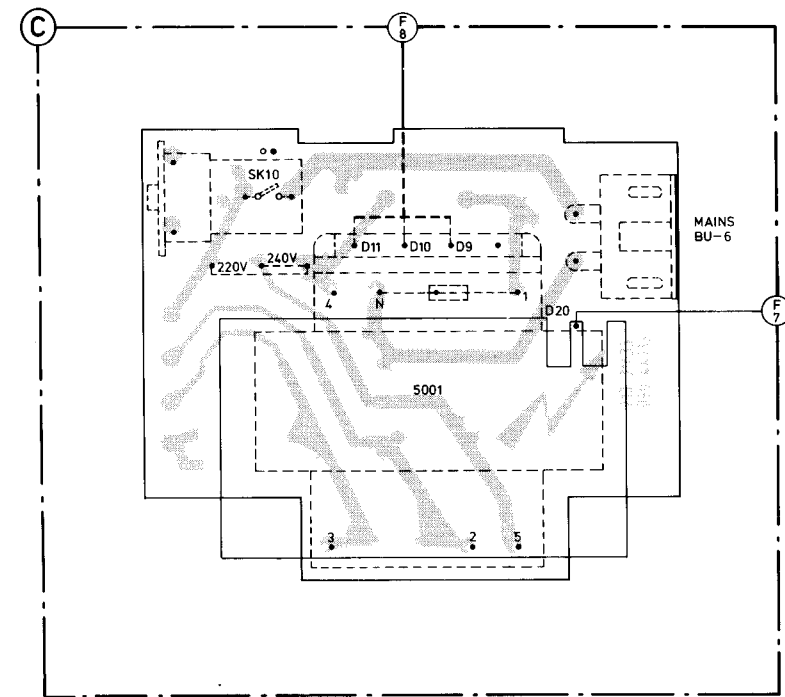
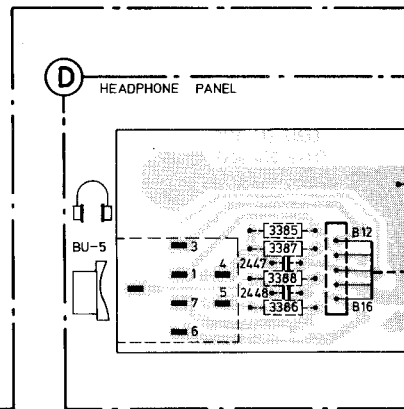
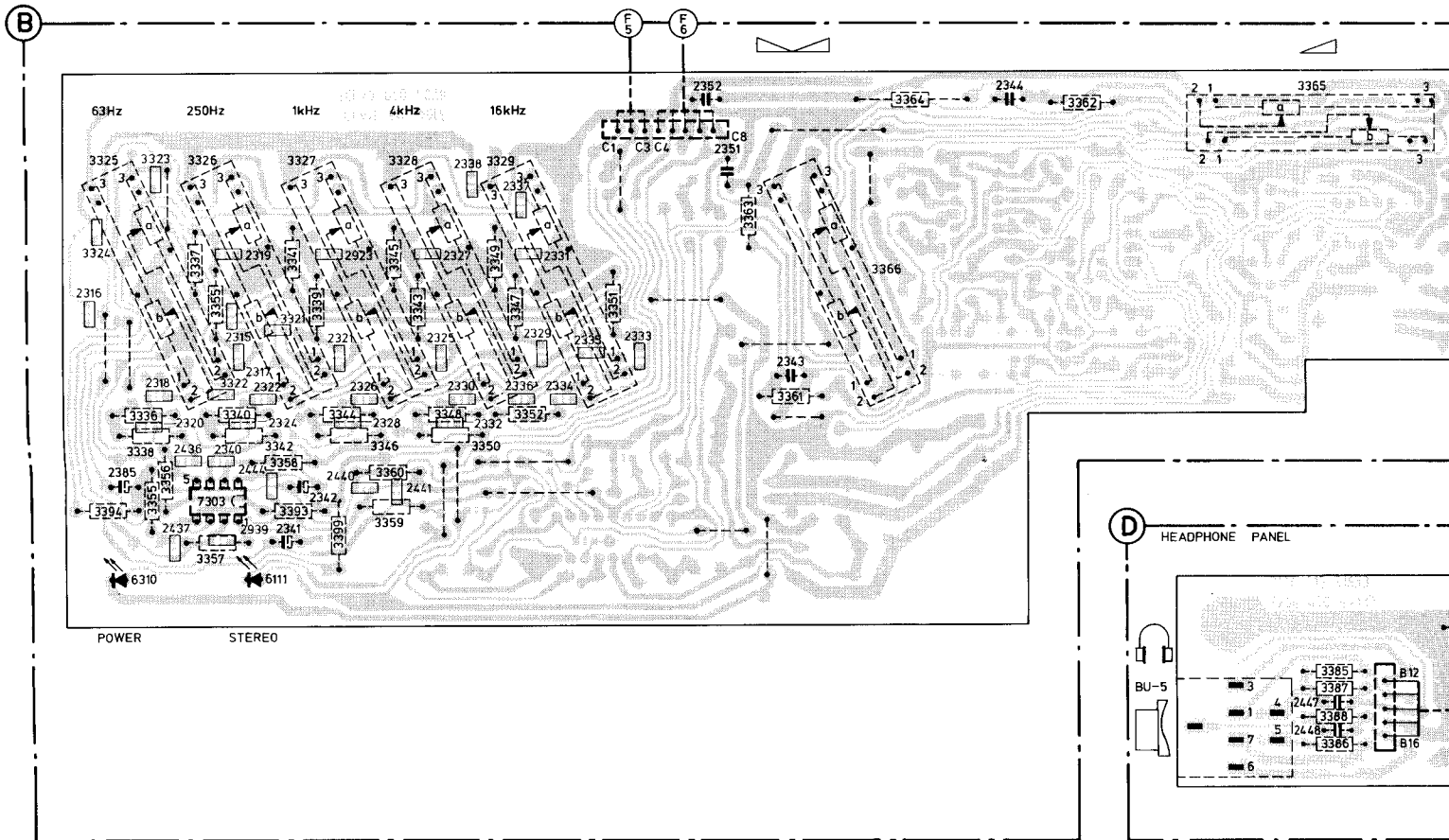
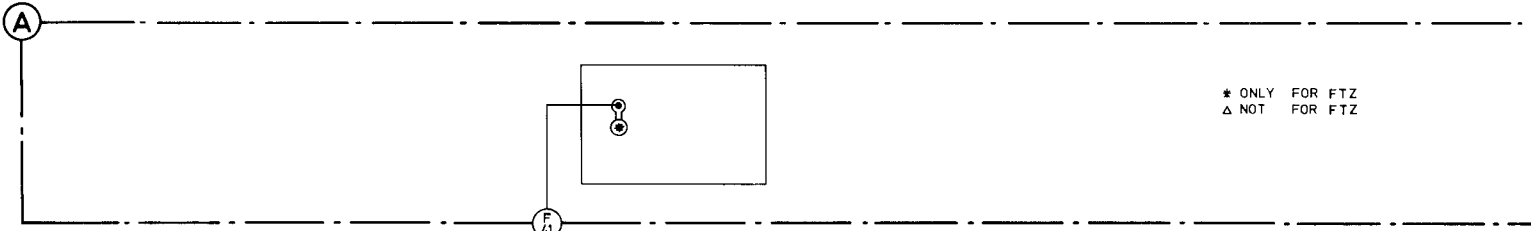

* ONLY FOR FTZ
 Δ NOT FOR FTZ

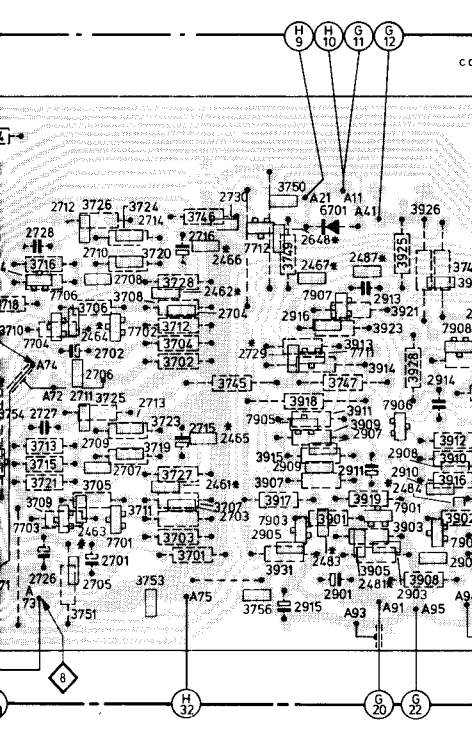
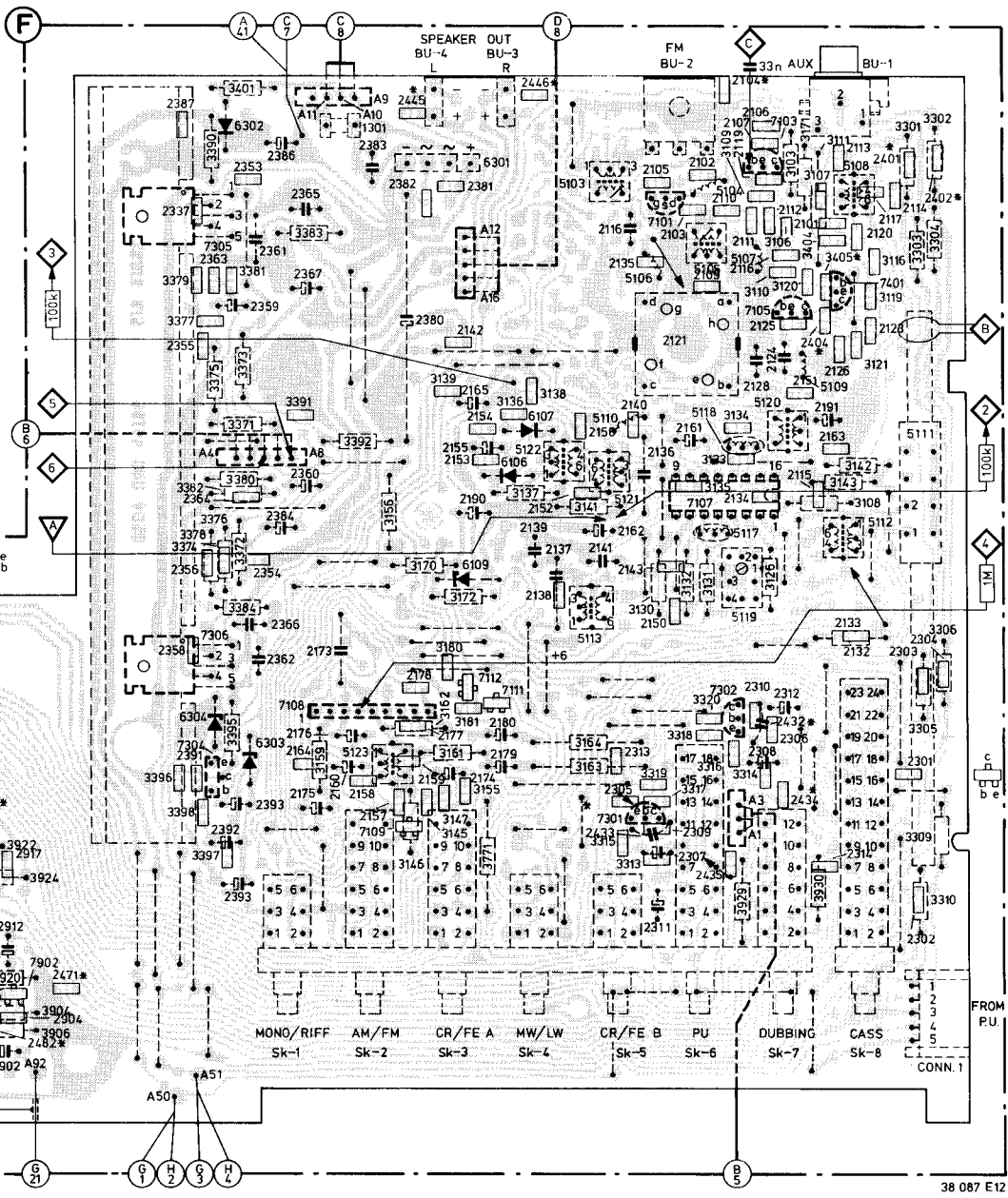
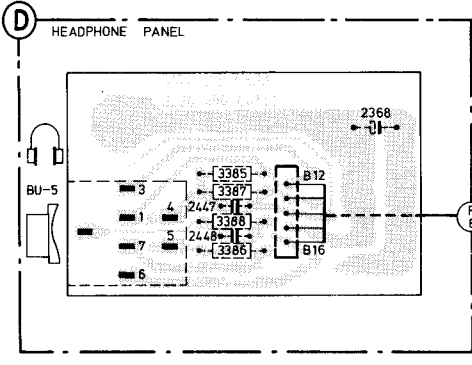
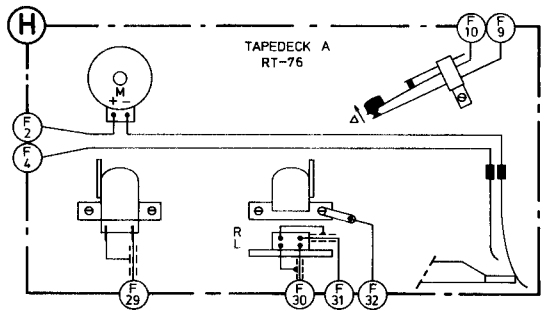
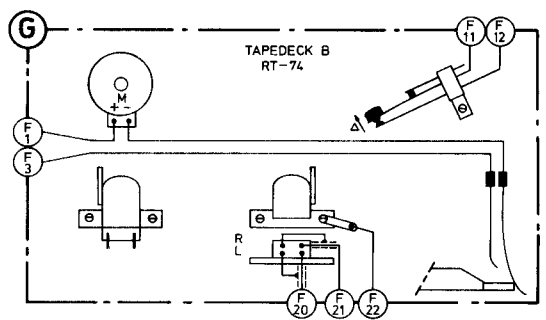
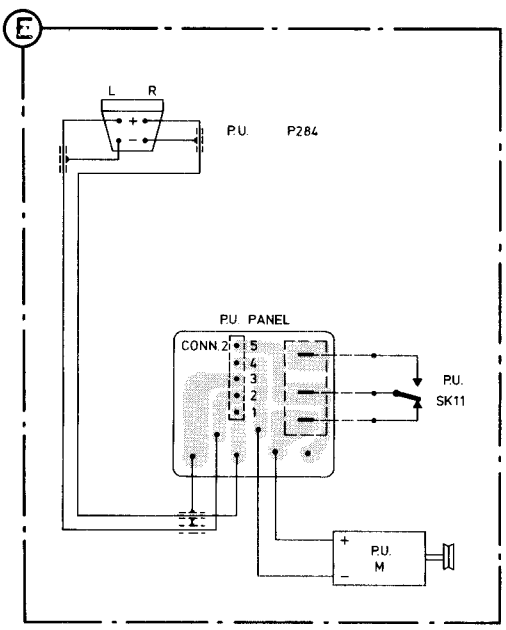
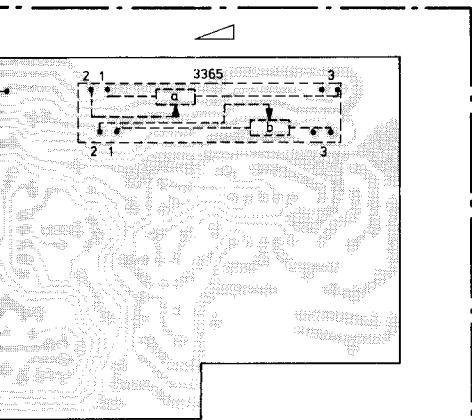

7301/7302

e = ⊥
b = 0.6 V
c = 5.7 V

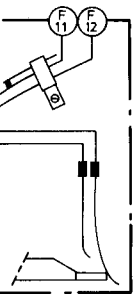

7303

1 = 7.1 V
2 = 7.1 V
3 = 7.1 V
4 = ⊥
5 = 7.1 V
6 = 7.1 V
7 = 7.1 V
8 = 14.4 V

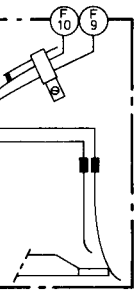

7105

e = 1.4 V
b = 0.6 V
c = 4.0 V

7304

e = 14.4 V
b = 15.6 V
c = 30.6 V

7101

g = 0 V
s = ⊥
d = 5.7 V

7103

e = 1.1 V
b = 1.9 V
c = 6.0 V

7703/7704

e = 2.2 V
b = 2.9 V
c = 6.1 V

7305/7306

1 = 15 V
2 = 15.4 V
3 = ⊥
4 = 15.4 V
5 = 30.6 V

7109

e = 0.3 V
b = 1.0 V
c = 6.7 V

7701/7702

e = 0 V
b = 0.6 V
c = 2.9 V

7905/7906

e = 6.4 V F 6.1 V C
b = 5.9 V F 5.4 V C
c = 6.3 V F 6.1 V C

7705/7706

e = 6.2 V F 5.9 V C
b = 5.8 V F 5.3 V C
c = 6.1 V F 5.9 V C

7901/7902

e = 0 V
b = 0.6 V
c = 2.8 V

7903/7904

e = 2.1 V
b = 2.8 V
c = 6.1 V

7107

1 = 1.4 V
2 = 0.6 V
3 = 0.6 V
4 = 5.6 V
5 = 3.9 V
6 = 0.7 V
7 = 5.6 V
8 = 5.6 V
9 = 5.5 V
10 = 5.5 V
11 = 1.3 V
12 = 0 V
13 = 0.7 V
14 = 5.2 V
15 = 0 V
16 = ⊥

7108

1 = 3.4 V
2 = 6.0 V
3 = 7.4 V
4 = 6.6 V
5 = ⊥
6 = 12.9 V
7 = 6.7 V
8 = 4.1 V
9 = 4.0 V

7707/7708

e = 0.4 V
b = 0 V
c = 14.5 V

7711/7712

e = 0 V
b = 0.2 V 0.6 V
c = 0 V

7709/7710

e = 0 V
b = 0.4 V
c = 0 V

7771

e = 0.6 V
b = 1.2 V
c = 8.6 V

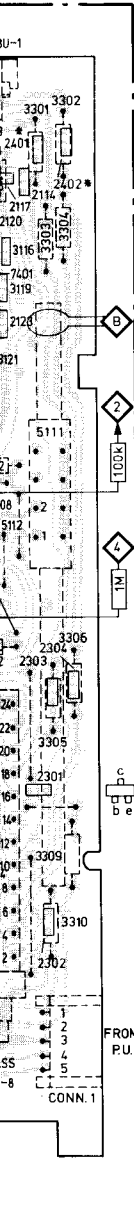

	15	16
TUNER		
PHONO		
CASS		
AUX		

38 216 A12

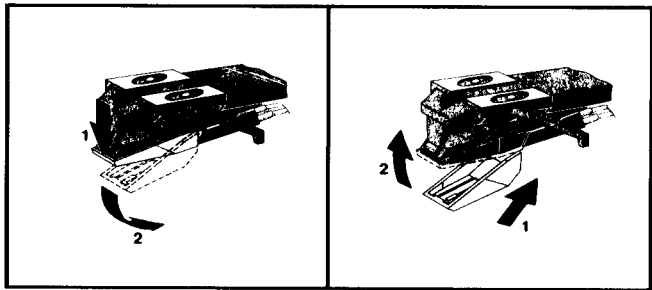

38 217 A12

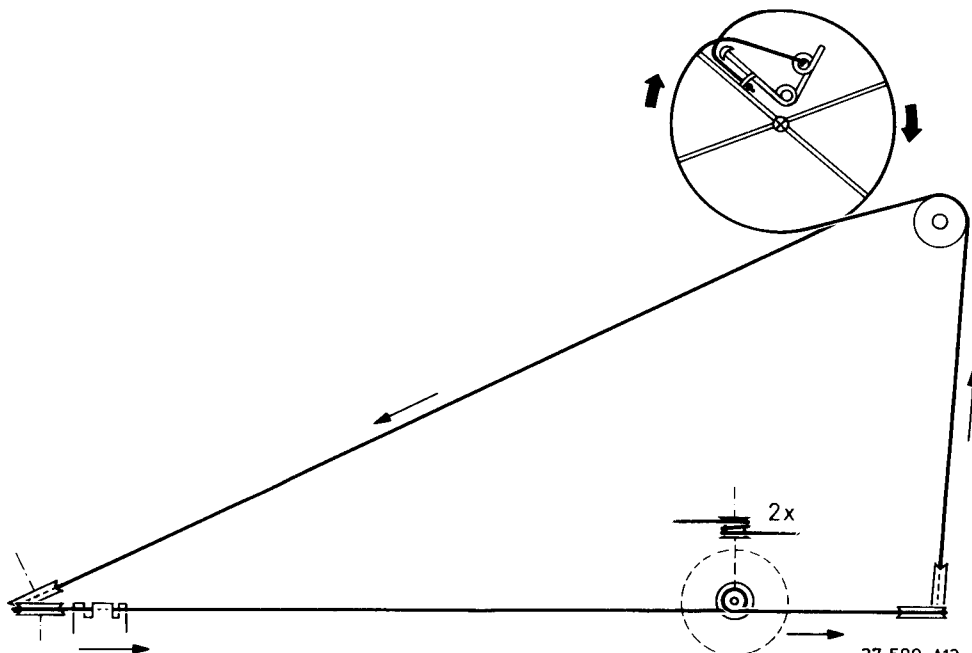

37 599 A12

1301	K18	2307	C 4	2314	F 5	2321	R10	2328	G10	2335	C 9	2342	G12	2354	G16	2361	B18	2368	G18	2386	N13	2427	D 2	2440	I12	3301	D 1	3310	I 2	3319	A 5	3325	H 8	3329	H 8	3329		
2301	E 3	2308	G 4	2315	O 7	2322	F10	2329	C10	2336	G 9	2343	D13	2355	C16	2362	F18	2380	L16	2387	N13	2432	F 6	2441	O12	3302	H 1	3313	C 4	3320	F 5	3326	D 8	3329	H 8	3335	H 8	3335
2302	J 3	2309	H 5	2316	H 7	2323	B10	2330	G10	2337	D 9	2344	H13	2356	H16	2363	D17	2381	L16	2390	H16	2433	B 6	2444	R12	3303	D 2	3314	H 4	3321	C 8	3326	H 8	3329	H 8	3336	D 8	3336
2303	D 2	2310	O 5	2317	R10	2324	F10	2331	C10	2338	H 9	2345	R11	2357	D16	2364	H17	2382	L17	2391	L15	2434	B 6	2445	B20	3304	I 2	3315	C 4	3322	O 8	3327	D 8	3329	H 8	3337	D 8	3337
2304	H 2	2311	C 5	2318	E10	2325	B10	2332	G10	2339	C12	2351	C15	2358	H16	2365	O18	2383	L18	2392	H14	2435	C 6	2446	H20	3305	O 2	3316	G 4	3323	H 8	3327	H 8	3329	H 8	3337	D 8	3337
2305	C 5	2312	G 5	2319	R10	2326	F10	2333	C10	2340	H12	2352	C15	2359	E16	2366	H18	2384	K13	2393	M13	2436	G11	2447	E20	3306	H 2	3317	B 5	3324	H 8	3328	D 8	3329	H 8	3338	D 8	3338
2306	H 5	2313	A 5	2320	E10	2327	B10	2334	H10	2341	B12	2353	C16	2360	I16	2367	C18	2385	L12	2426	I 2	2437	B11	2448	F20	3309	E 2	3318	F 5	3325	D 7	3328	H 9	3329	H 9	3338	H 9	3338

1 2 3 4 5 6 7 8 9 10 11 12

A B C D E F G H I J K L M N

**F1652
A.F. CIRCUIT**

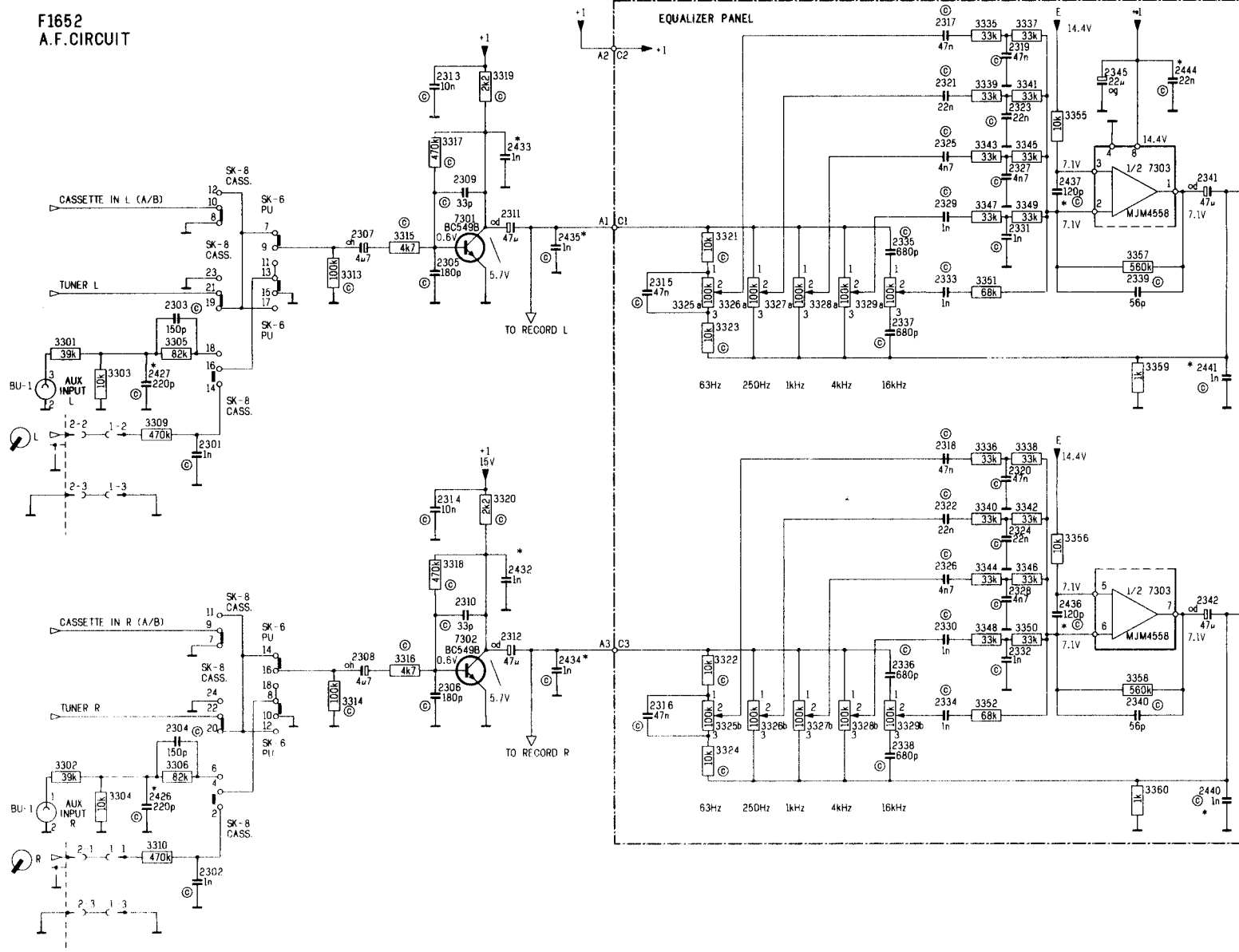

C → 1-1= CONNECTOR 1 PIN 1
ALL RESISTORS UNLESS STATED OTHERWISE.
ITEMS MARKED WITH * ONLY FOR FTZ

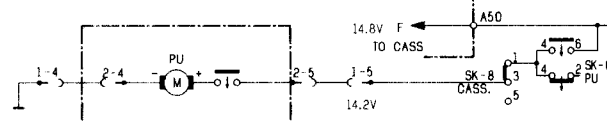
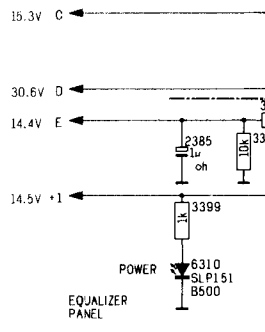
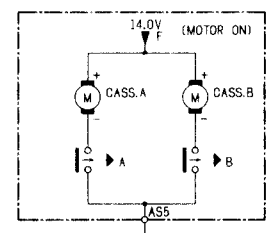
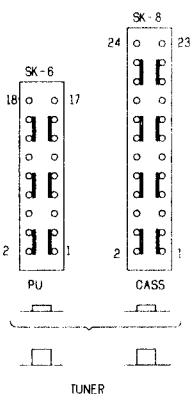

1 2 3 4 5 6 7 8 9 10 11 12

1 D 1 3310 I 2 3319 A 5 3325 H 8 3329 D 9 3340 F10 3347 C10 3356 F11 3363 C14 3372 G16 3379 D18 3386 F19 3394 K13 5001 K19 7302 G 5
 2 D 1 3313 C 4 3320 F 5 3326 D 8 3329 H 9 3341 A10 3348 G10 3357 C12 3364 H14 3373 B16 3380 I18 3387 E19 3395 L16 6301 L17 7304 L14
 3 D 2 3314 H 4 3321 C 8 3326 H 8 3329 A10 3342 F10 3348 C10 3358 H12 3365 C14 3374 F16 3381 D18 3388 F19 3396 M16 6302 M17 7305 B17
 4 I 2 3315 C 4 3322 D 8 3327 D 8 3336 E10 3343 B10 3350 C10 3359 D12 3365 G14 3375 C16 3382 H18 3390 N14 3397 M15 6303 M15 7306 G17
 5 D 2 3316 G 4 3323 D 8 3327 H 8 3337 F10 3344 F10 3351 C10 3360 I12 3366 G13 3376 G16 3383 C18 3391 K14 3398 M14 6304 M14
 6 H 2 3317 B 5 3324 H 8 3326 D 8 3338 E10 3345 B10 3352 H10 3361 C14 3366 G13 3377 D16 3384 H18 3392 J14 3399 L12 6310 M12
 9 E 2 3318 F 5 3325 D 7 3328 H 9 3339 A10 3346 F10 3355 B11 3362 G14 3371 B16 3378 I16 3385 D19 3393 K13 3401 H18 7301 C 5

10 11 12 13 14 15 16 17 18 19 20 21

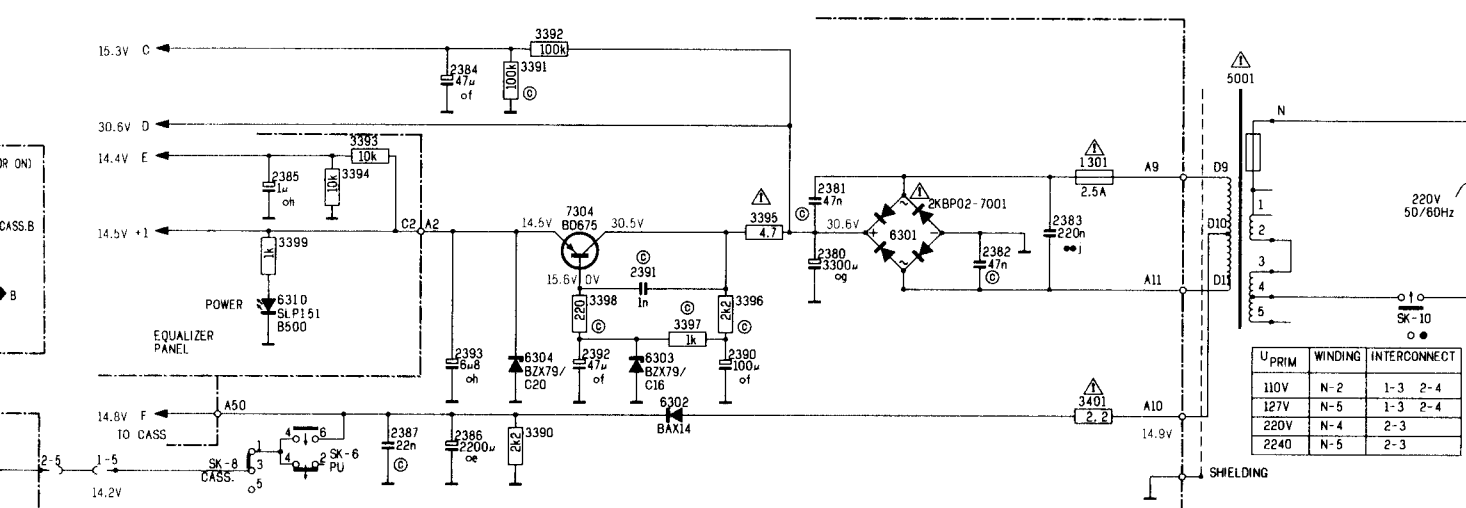
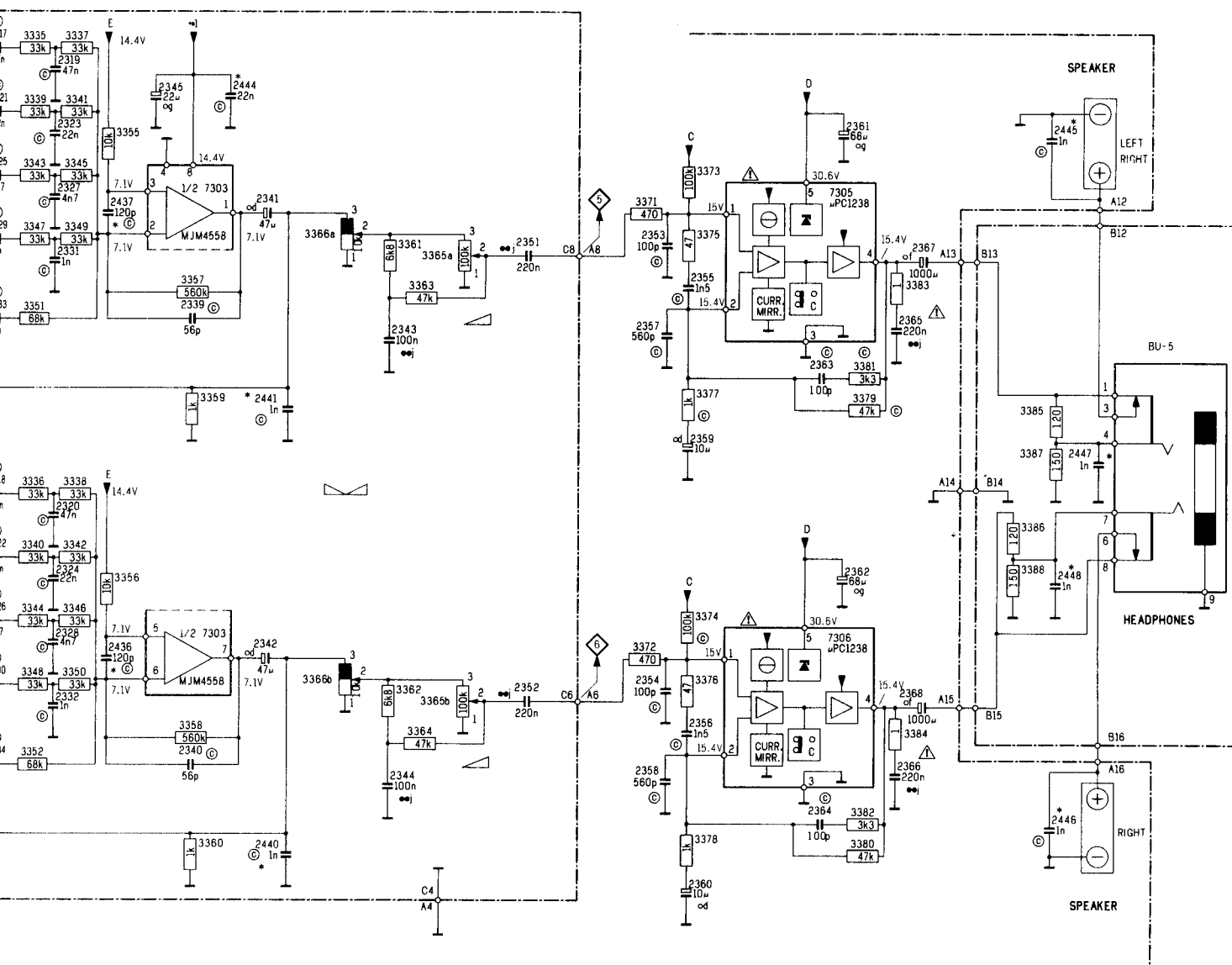

U PRIM	WINDING	INTERCONNECT
110V	N-2	1-3 2-4
127V	N-5	1-3 2-4
220V	N-4	2-3
2240	N-5	2-3

AF PART

A

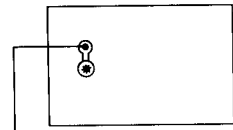

* ONLY FOR FTZ
 Δ NOT FOR FTZ

F5

B

F5

F6

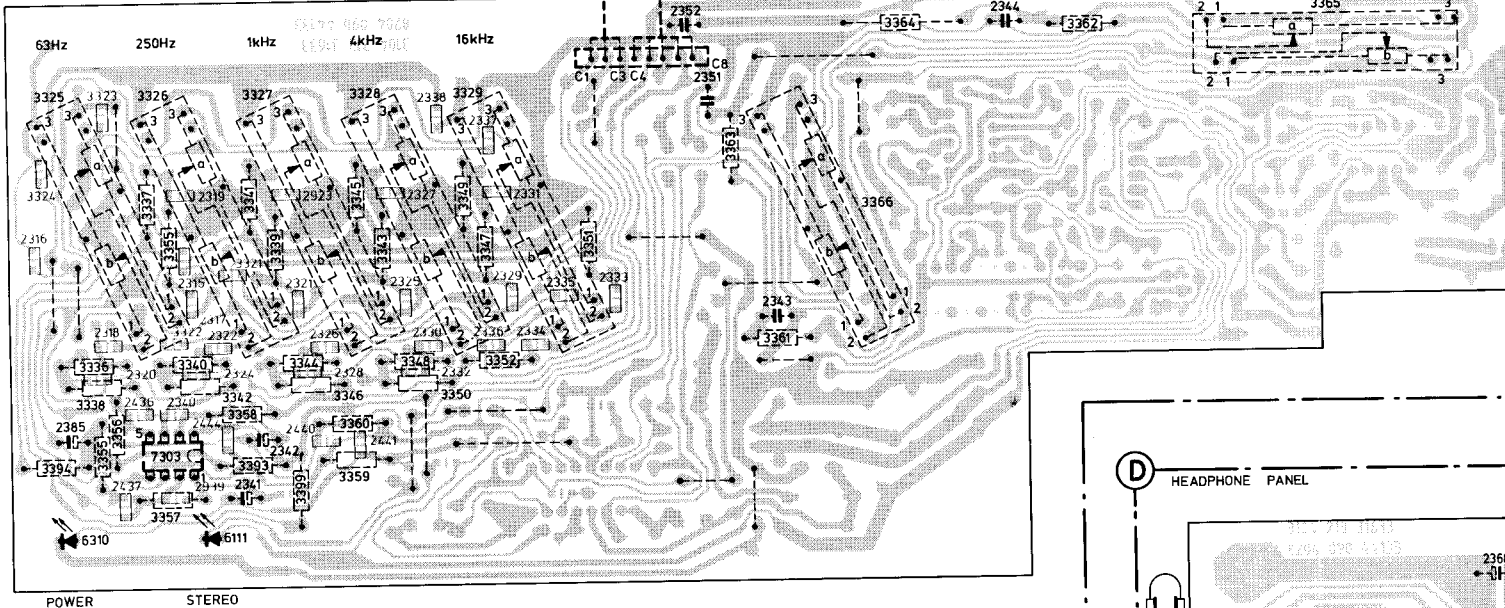

D

HEADPHONE PANEL

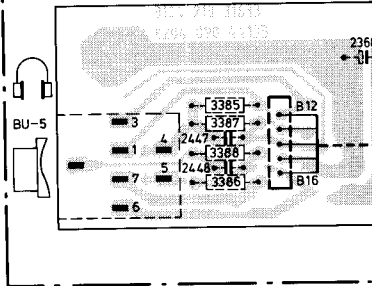

C

F8

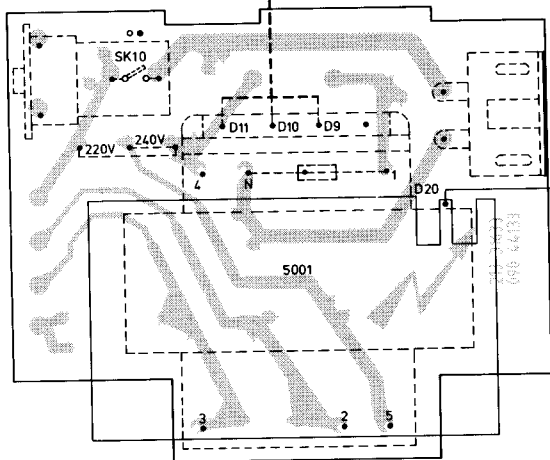

MAINS BU-6

5001

F7

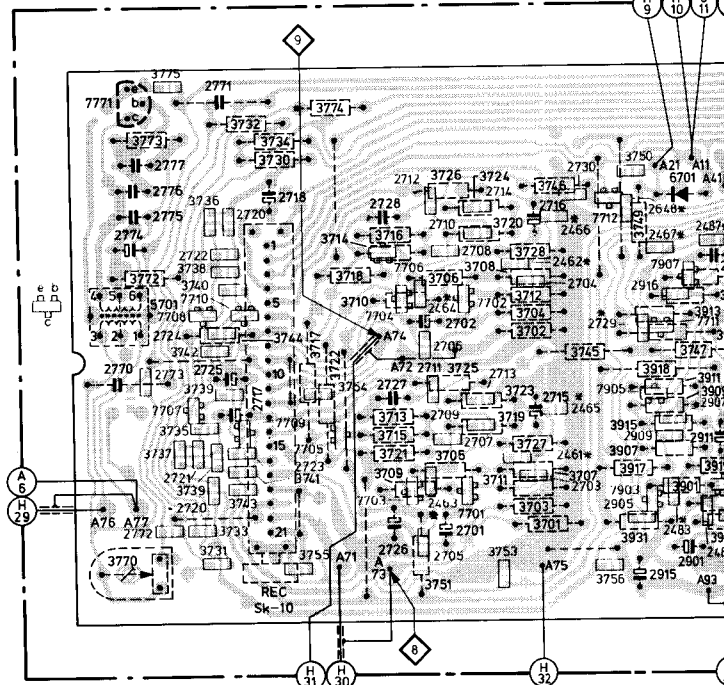

A6

H29

H31

H30

H32

* ONLY FOR FTZ
 Δ NOT FOR FTZ

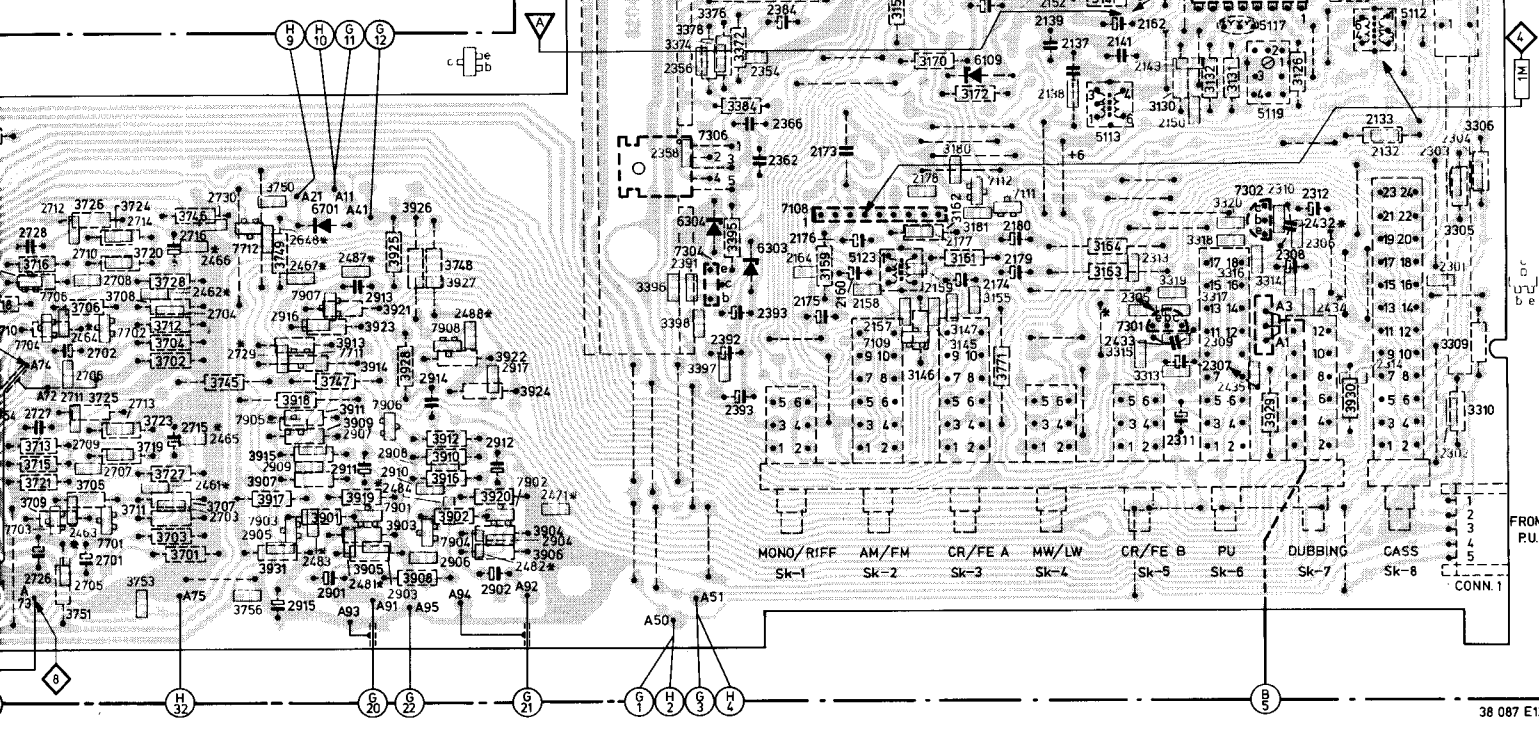
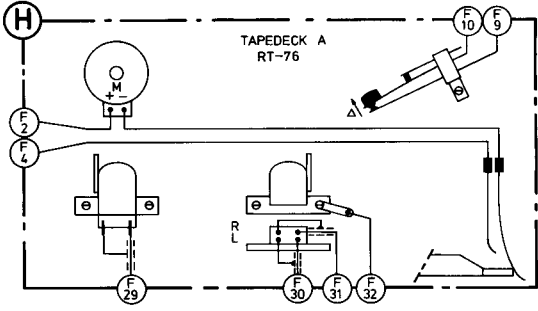
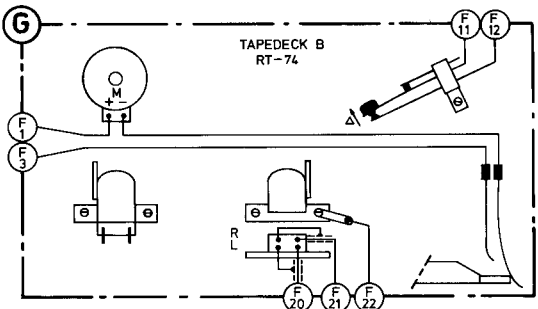
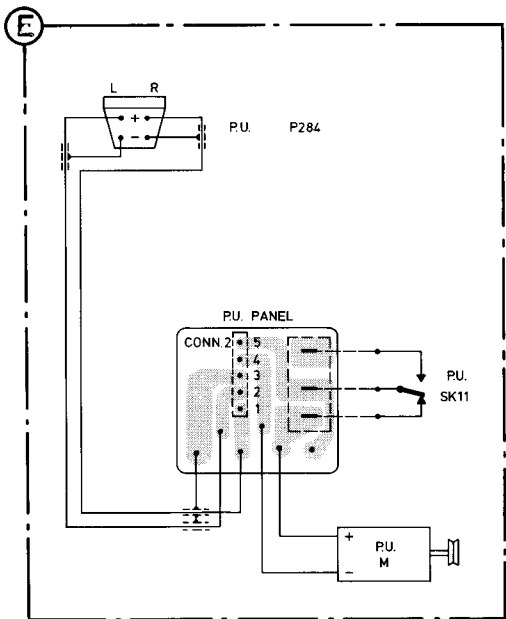
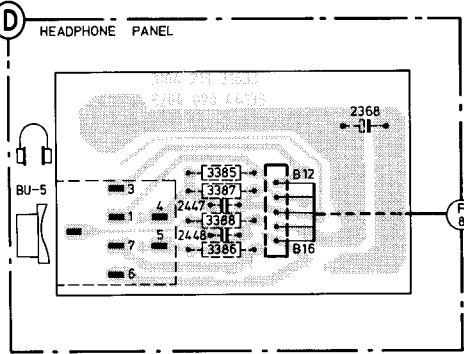
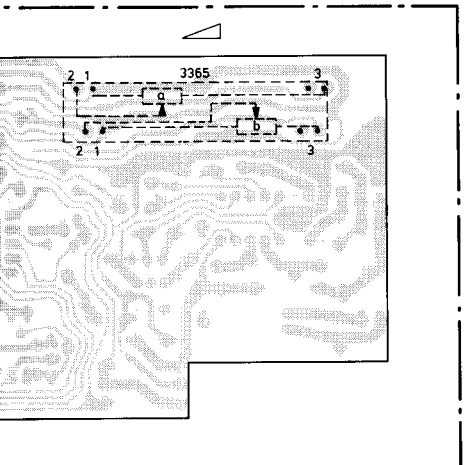

7301/7302

e = \perp
b = 0.6 V
c = 5.7 V

7101

g = 0 V
s = \perp
d = 5.7 V

7109

e = 0.3 V 0 V
b = 1.0 V 0.3 V
c = 6.7 V 7.4 V

7901/7902

e = 0 V
b = 0.6 V
c = 2.8 V

7107

1 = 1.4 V 0 V
2 = 0.6 V 1.4 V
3 = 0.6 V 1.4 V
4 = 5.6 V 5.9 V
5 = 3.9 V 5.9 V
6 = 0.7 V 5.9 V
7 = 5.6 V 5.9 V
8 = 5.6 V 5.9 V
9 = 5.5 V 5.9 V
10 = 5.5 V 5.9 V
11 = 1.3 V 1.3 V
12 = 0 V
13 = 0.7 V
14 = 5.2 V 5.6 V
15 = 0 V
16 = \perp

7707/7708

e = 0.4 V
b = 0 V
c = 14.5 V

7709/7710

e = 0 V
b = 0.4 V
c = 0 V

7303

1 = 7.1 V
2 = 7.1 V
3 = 7.1 V
4 = \perp
5 = 7.1 V
6 = 7.1 V
7 = 7.1 V
8 = 14.4 V

7103

e = 1.1 V
b = 1.9 V
c = 6.0 V

7701/7702

e = 0 V
b = 0.6 V
c = 2.9 V

7903/7904

e = 2.1 V
b = 2.8 V
c = 6.1 V

7105

e = 1.4 V
b = 0.6 V
c = 4.0 V

7703/7704

e = 2.2 V
b = 2.9 V
c = 6.1 V

7905/7906

e = 6.4 V | F 6.1 V | C
b = 5.9 V | F 5.4 V | C
c = 6.3 V | F 6.1 V | C

7108

1 = 3.4 V
2 = 6.0 V
3 = 7.4 V
4 = 6.6 V 5.6 V
5 = \perp
6 = 12.9 V
7 = 6.7 V 7.5 V
8 = 4.1 V
9 = 4.0 V

7711/7712

e = 0 V
b = 0.2 V 0.6 V
c = 0 V

7771

e = 0.6 V
b = 1.2 V
c = 8.6 V

7304

e = 14.4 V
b = 15.6 V
c = 30.6 V

7305/7306

1 = 15 V
2 = 15.4 V
3 = \perp
4 = 15.4 V
5 = 30.6 V

7705/7706

e = 6.2 V | F 5.9 V | C
b = 5.8 V | F 5.3 V | C
c = 6.1 V | F 5.9 V | C

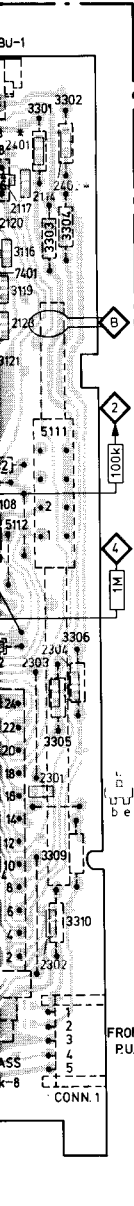
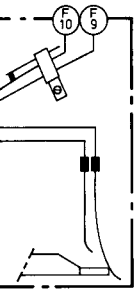
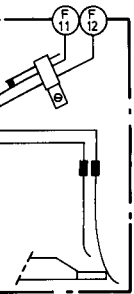

	15	16
TUNER		
PHONO		
CASS		
AUX		

38 216 A12

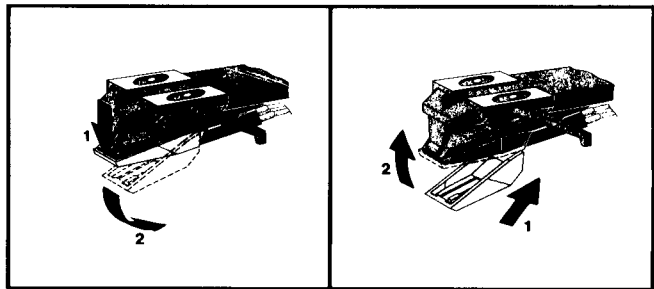

38 217 A12

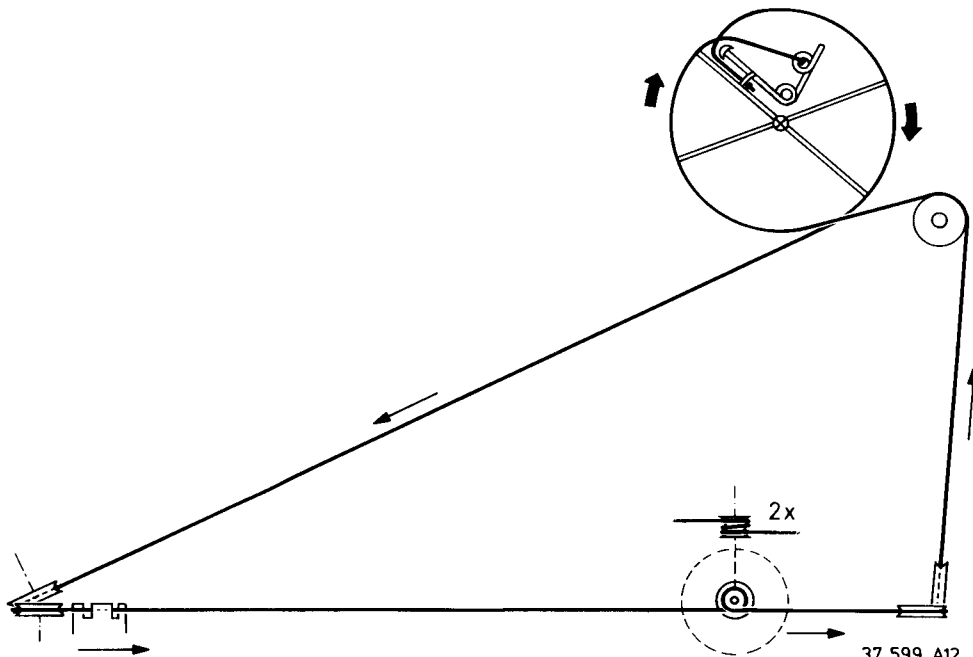

37 599 A12

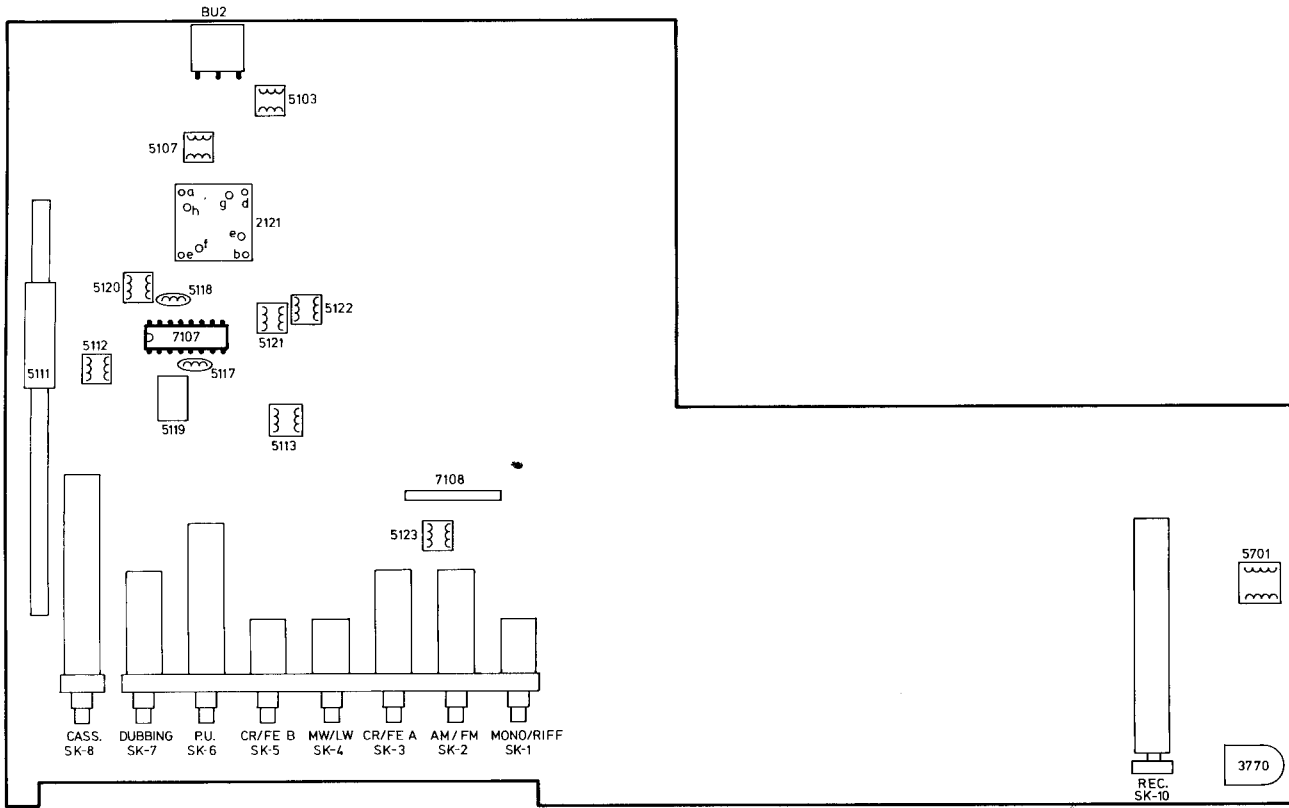

38516C12

ALIGNMENT

General

- During the a signals as lo
- Alignment of
- For FM: App kHz at a fre
- For AM: App sweep of 10

ALIGNMENT























General

- During the alignment, keep the levels of the injected signals as low as possible.
- Alignment of IF stages requires a sweep signal.
For FM: Apply a 10.7 MHz signal with a sweep of 300 kHz at a frequency of 50 Hz.
- For AM: Apply a 450 kHz (468 kHz) signal with a sweep of 10 kHz at a frequency of 50 Hz.



Equipment required

- RF generator
- Oscilloscope
- DC-millivoltmeter
- AC-millivoltmeter
- Frequency counter



FM-IF

SK switch	 signal	 to	 tune in	DETUNE	 adjust	 oscilloscope	 DC mV meter	
FM SK-2	10.7 MHz $\Delta f = 300$ kHz (50 Hz)					   center		
	fo=f generator $\Delta f = 10$ kHz (50 Hz)					5108		   symmetrical
	10.7 MHz $\Delta f = 300$ kHz (50 Hz) 1 mV					5122 5121		   symmetrical
	10.7 MHz No sweep					5122		  DC  0 V \pm 30 mV
								

FM-oscillator

FM SK-2	87.54 MHz mod. 1 kHz $\Delta f = 22.5$ kHz		max. cap. 2121		5109		
	108.3 MHz mod. 1 kHz $\Delta f = 22.5$ kHz		min. cap.		2121e		

FM-RF antenna section

SK-2	87.54 MHz mod. 1 kHz $\Delta f = 22.5$ kHz				5105		
	108.3 MHz mod. 1 kHz $\Delta f = 22.5$ kHz				2121h		

Stereo-decoder

FM SK-2	No signal				3158	Counter  76 kHz \pm 300 Hz	
------------	-----------	--	--	--	------	---------------------------------------------------------------------------------------------------------------------------	--

 Repeat

GB

- 1 Place the peak of the band-pass curve in the middle of the picture by shifting the sweep frequency.
- 2 Adjust for maximum height and symmetry.
- 3 Adjust for linearity and symmetry of the S-curve.
- B Open solder bridge 

NL

- 1 De top van de doorlaat curve, door verschuiven van wobbelfrequentie, in het midden van het scherm plaatsen.
- 2 Afregelen op maximum hoogte en symmetrie.
- 3 Afregelen op lineariteit en symmetrie van de S-kurve.
- B Open soldeerbrug 













F

- 1 En décalant la fréquence de wobulation, placer la crête de la courbe de réponse au centre de l'écran.
- 2 Ajuster pour avoir une courbe d'amplitude maximale et de bonne symétrie.
- 3 Ajuster pour avoir une courbe en S de bonne linéarité et de bonne symétrie.
- B Ouvrir le pontet 



I

- 1 Portare la cresta della curva di risposta al centro dello schermo per mezzo di scivolamento della frequenza di modulazione.
- 2 Regolare per altezza e simmetria massima.
- 3 Regolare per linearità e simmetria della curva ad S.
- B Aprire il ponticello 



AM-IF

SK						
switch	signal	to	tune in	adjust	oscilloscope	DC mV meter
AM SK-2 MW SK-4	450 kHz $\Delta f = 10$ kHz (50 Hz)		2121 max. cap.		 1 1 center  fo	
	fo=f generator $\Delta f = 10$ kHz (50 Hz)			5119 5120	symmetrical  MAX. 	

AM-RF-oscillator

AM SK-2 LW SK-4	147 kHz mod: 1 kHz 30%		2121 max. cap.	5113	 max. ~
AM SK-2 MW SK-4	1635 kHz mod: 1 kHz 30%		2121 min. cap.	2121f	

AM-RF-antenna section

AM SK-2 MW SK-4	560 kHz mod: 1 kHz 30%			5103	 max. ~
	1500 kHz mod: 1 kHz 30%			2121g	
AM SK-2 LW SK-4	160 kHz mod: 1 kHz 30%			5109	

D

- 1 Die Spitze der Durchlasskurve in der Mitte des Bildes legen dadurch, dass man die Wobelfrequenz verschiebt.
- 2 Abgleichen auf Maximalhöhe und Symmetrie.
- 3 Abgleichen auf Linearität und Symmetrie der S-Kurve.

GB Electrical measurements and adjustments "Recorder"

- *A. - The maximum permissible speed deviation is $\pm 0.5\%$.
Moreover, the wow and flutter value can be read.
- This value should not exceed 0.35%.
- *B. - Connect the Service cassette set to the apparatus via one of the loudspeaker connectors.
- Set the apparatus to the play back position with the 50 Hz cassette service set.
- With R at the back of the motor, adjust for minimum variation of the indicator reading.
- *C. - If the accuracy requirements are less stringent a high quality ferro (normal) cassette may be used as an alternative.
- *D. - If the adjustment is correct the frequency response curve will be similar to curve b in Fig. 2 (distortion $\leq 5\%$).

F Mesurer electriques et reglages "Recorder"

- *A. - L'écart de vitesse maximum admissible est de $\pm 0.5\%$.
La taux de pleurage pourra également être lu lors de cette mesure.
- Cette valeur ne doit pas dépasser 0.35%.
- *B. - Via een van de luidsprekerconnectors het Service-cassettedeel met het apparaat verbinden.
- Zet het apparaat in de weergeefstand met de 50 Hz cassette uit het Service-cassettedeel.
- Met R aan de achterzijde van de motor op minimale variatie van de indicatoraflezing instellen.
- *C. - Als de nauwkeurigheidseisen minder streng zijn, kan als alternatief een ferro-cassette (normal) van hoge kwaliteit gebruikt worden.
- *D. - Als de instelling juist is, zal de frekwentiekromme gelijk zijn aan kromme b in Fig. 2 (vervorming $\leq 5\%$).

I Misure e regolazione elettriche "Recorder"

- *A. - La deviazione massima di velocità è $\pm 0.5\%$.
Inoltre, può essere rilevato il wow e flutter.
- Questo valore non deve eccedere dello 0.35%.
- *B. - Collegare lo strumento di servizio al connettore di uscita di una cassa acustica dell'apparecchio.
- Posizionare l'apparecchio in riproduzione e usare la cassetta test a 50 Hz.
- Regolare la velocità del motore (R), per la minima deviazione dello strumento.

4 Lötbrücke  öffnen.

"Bei notwendigem Abgleich ist das Gerät auf die gesetzlich vorgeschriebenen Eckfrequenzen abzugleichen".
>87.2 MHz <108.5 MHz.

NL Elektrische metingen en instellingen "Recorder"

- *A. - De hoogst toelaatbare snelheidsafwijking bedraagt $\pm 0.5\%$.
Tevens kan bij deze meting de jengelwaarde afgelezen worden.
- Deze waarde mag niet hoger zijn dan 0.35%.
- *B. - Via een van de luidsprekerconnectors het Service-cassettedeel met het apparaat verbinden.
- Zet het apparaat in de weergeefstand met de 50 Hz cassette uit het Service-cassettedeel.
- Met R aan de achterzijde van de motor op minimale variatie van de indicatoraflezing instellen.
- *C. - Als de nauwkeurigheidseisen minder streng zijn, kan als alternatief een ferro-cassette (normal) van hoge kwaliteit gebruikt worden.
- *D. - Als de instelling juist is, zal de frekwentiekromme gelijk zijn aan kromme b in Fig. 2 (vervorming $\leq 5\%$).

D Elektrische Messungen und Einstellungen "Recorder"

- *A. - Die höchstzulässige Geschwindigkeitsabweichung beträgt $\pm 0.5\%$.
Auch lässt sich bei dieser Messung der Jaulwert ablesen.
- Dieser Wert darf 0.35% nicht überschreiten.
- *B. - Über einen der Lautsprecherkonnektoren den Service-Cassettenteil mit dem Gerät verbinden.
- Mit dem 50-Hz-Cassette aus dem Service-Cassettenteil das Gerät in die Wiedergabestellung bringen.
- Mit R auf der Rückseite des Motors auf mindest-Schwankungen der Anzeigerablesung einstellen.
- *C. - Wenn die Genauigkeitsanforderungen weniger streng sind, kann als Alternative eine Hochleistungs-ferrocassette (Normal) benutzt werden.
- *D. - Wenn die Einstellung richtig ist, wird der Frequenzgang gleich der Kurve b in Bild 2 (Verzerrung $\leq 5\%$) sein.

- *C. - Per necessità può essere una cassetta di alta qualità al ferro (normale).
- *D. - Se la regolazione è corretta la curva di risposta in frequenza sarà simile alla curva b in Fig. 2 (distorione $\leq 5\%$).

ELECTRICAL RECORDER A

General cond

- Prior to any running, heat and cleaned
- The measur left-hand ch
- The corresp for the right
- The voltage

RECORDER A +

Recorder	Ad
A+B	P M M
A+B	A R
A+B	P se
A	
A	
A+B	

RECORD PLAYER

Recorder	Ad



ELECTRICAL MEASUREMENTS AND ADJUSTMENTS RECORDER AND RECORD PLAYER

General conditions recorder

- Prior to any measurement or adjustment with the tape running, heads and tape guides should be degaussed and cleaned.
- The measurements and adjustments are related to the left-hand channel.
- The corresponding test points and adjusting elements for the right-hand channel are given in brackets.
- The voltages have been measured relative to earth.

Required test equipment and test cassettes

- LF generator
- AC mV meter
- Wow and flutter meter
- Frequency counter
- Cassette service set 801CSS 4822 395 30078
- Universal test cassette SBC420Fe 4822 397 30071

RECORDER A + B

Recorder	Adjustment	Cassette	Recorder in position SK	Apply signal to	Measure on	Read on	Adjust with	Adjust to
A+B	Playback speed Method 1 or Method 2	3150 Hz part of SBC420Fe	PLAY	-	Loudspeaker output ⑤ (⑥)	Wow and flutter meter	Trimpotmeter R at the back of the motor	*A
		Test cassette set 801/CSS	PLAY	-	Loudspeaker output BU3-4	indicator on test set	Trimpotmeter R at the back of the motor	*B
A+B	Azimuth R/P head	8 kHz part of SBC420Fe	PLAY	-	⑤ (⑥)	AC mV meter or oscilloscope	Left screw on R/P head	Max. output L+R
A+B	Playback sensitivity	315 Hz-0 dB part of SBC420Fe	PLAY	-	⑤ ⑥	AC mV meter	-	90 mV
A	BIAS	SBC420Fe side-2 °C	REC+PLAY	-	⑧ ⑨	AC mV meter	3770	9 mV
A	Erase osc.	Empty cassette	REC PLAY Cr RIF OFF	-	⑩	Freq. counter	5751	53 kHz ± 5 kHz
			RIF ON	-	⑩	Freq. counter	5751	fosc. + 8 kHz ± 4 kHz
			RIF OFF Normal	-	⑩	DC mV meter	B -3 V ± 1 dBc	
			RIF OFF Cr	-	⑩	DC mV meter	19 V ± 1 dB =B	
A+B		Rewind recording made with deck A	PLAY	-	⑤ (⑥)	AC mV meter		See graph Fig. 1 if necessary repeat adjustment *D

RECORD PLAYER

Recorder	Adjustment	Cassette	Recorder in position SK	Apply signal to	Measure on	Read on	Adjust with	Adjust to
	Speed		SK14 33 ¹ / ₃ rpm			Stroboscope	Trimpotmeter inside motor	33 ¹ / ₃ rpm

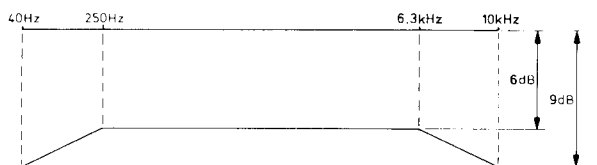

Fig. 1

23 742 A12/A

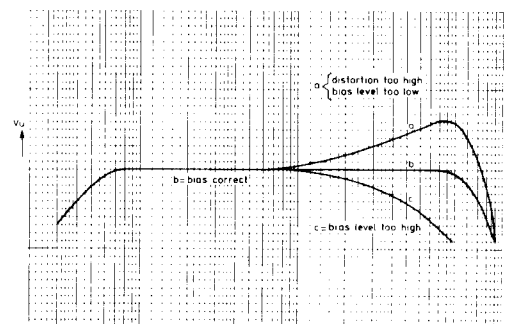
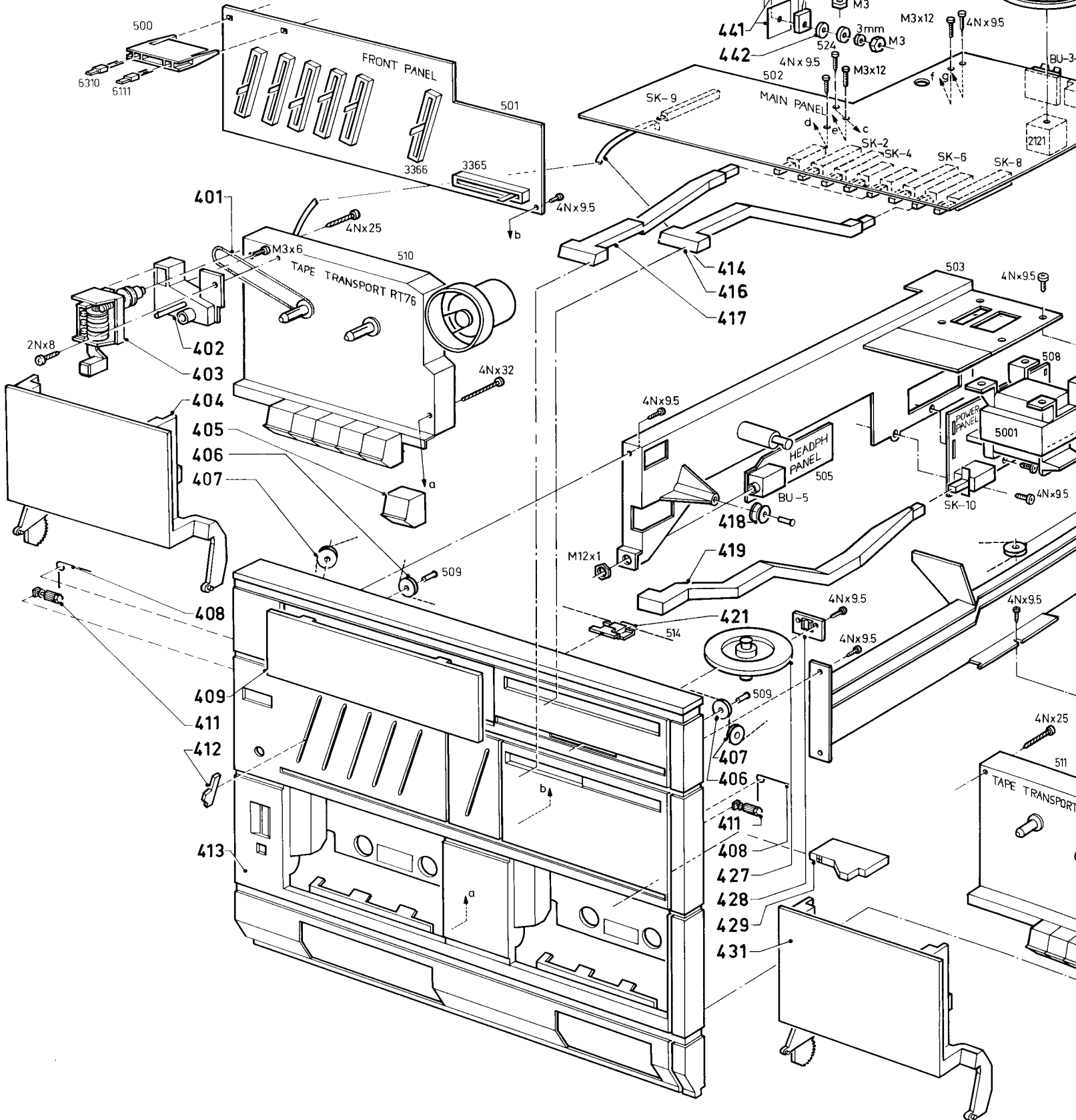
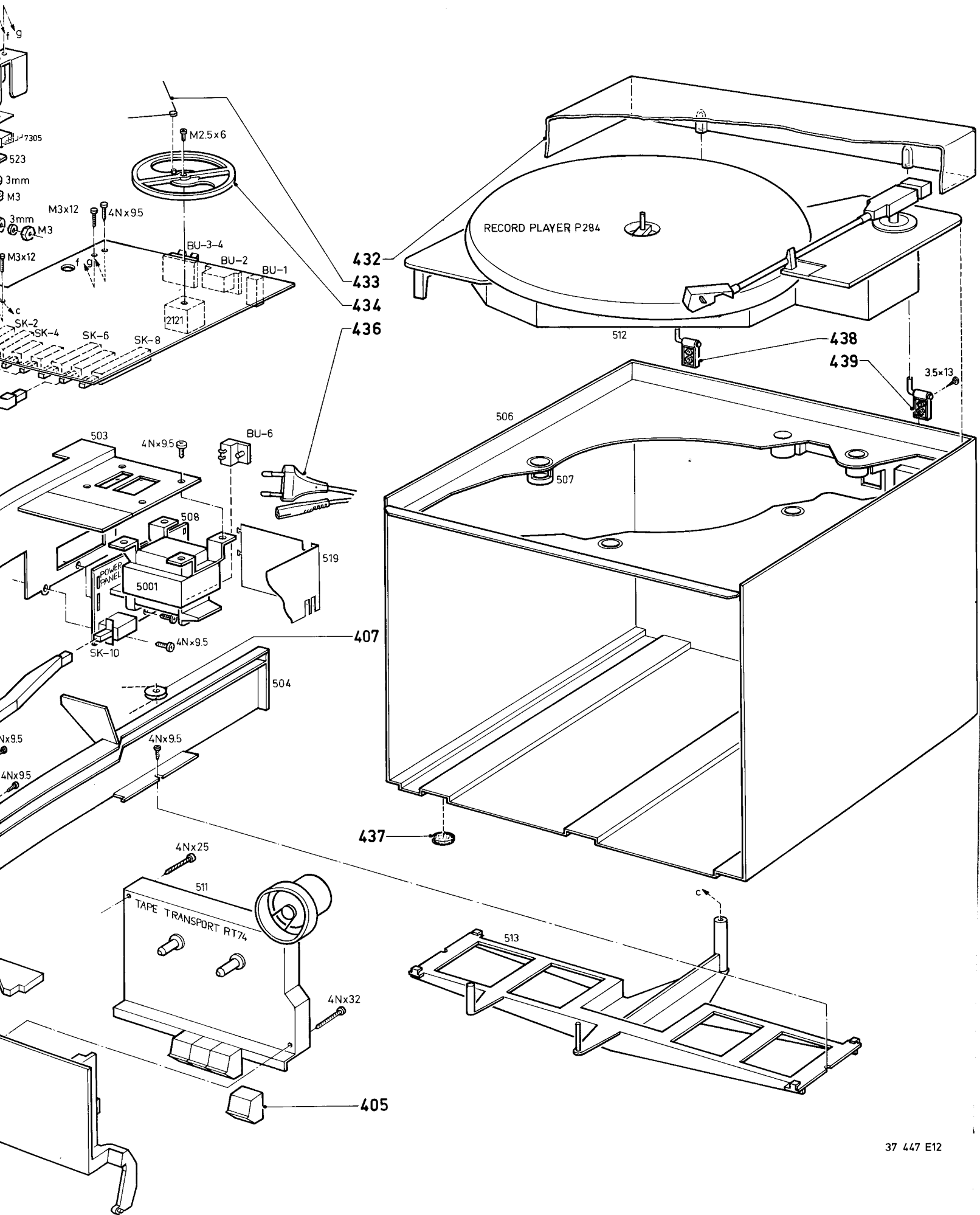

Fig. 2

29 476 A12

- | | | | | | |
|-----|----------------|-----|----------------|-----|-----------------------|
| 401 | 4822 358 10087 | 414 | 4822 492 90088 | 436 | 4822 321 30214 /30/32 |
| 402 | 4822 256 90798 | 416 | 4822 410 30419 | 436 | 4822 321 30306 /35 |
| 403 | 4822 349 50209 | 417 | 4822 410 30421 | 437 | 4822 462 40683 |
| 404 | 4822 426 60329 | 419 | 4822 410 30422 | 438 | 4822 417 10631 |
| 405 | 4822 410 24248 | 421 | 4822 450 80955 | 439 | 4822 417 10631 |
| 406 | 4822 528 80802 | 427 | 4822 528 81042 | | |
| 407 | 4822 528 50155 | 428 | 4822 256 90797 | | |
| 408 | 4822 492 41091 | 429 | 4822 411 61137 | | |
| 409 | 4822 333 30156 | 431 | 4822 426 60328 | | |
| 411 | 4822 535 70528 | 432 | 4822 426 60327 | | |
| 412 | 4822 411 61138 | 433 | 4822 492 31667 | | |
| 413 | 4822 426 50728 | 434 | 4822 528 80915 | | |





BAX14		4822 130 34193	2109	Chip 27 pF N220	4822 122 32564
BA220		4822 130 34221	2121	Varco	4822 125 50172
BA317		4822 130 30847	2128	Cer. N330 27p	4822 122 32706
BZX79/C16		4822 130 34268	2136	PS cap 365 p 630 V	4822 121 50803
BZX79/C20		4822 130 34499	2137	PS cap foil 324 p 630 V	4822 121 50542
BZX79/C7V5		4822 130 30861	2139	18 pF N1500 PM2	4822 122 32567
SLP151B50C		4822 130 32323	2173	PS cap 1 nF 630 V PM1	4822 121 50591
SLP251B50C		4822 130 32057			
1N4148		4822 130 30621			
2KBP02-7001		4822 130 50363			
BC548C		4822 130 44196	5001	Trafo mains	4822 146 21053
BC549B		4822 130 40936	5103	Aerial trafo sym	4822 157 51233
BC848B	Chip marked	5322 130 41982	5104	Absorb. coil	4822 156 10641
BC849C	Chip	4822 130 42614	5105	RF coil	4822 157 51693
BC858B		5322 130 41983	5106	Absorb. coil	4822 156 10641
BD675		5322 130 44786	5107	Coil 0,4 μH	4822 157 50967
BF241		4822 130 40898	5108	10.7 MHz	4822 153 50206
BF494B		4822 130 41376	5109	Osc. coil	4822 157 51618
2SK193L		4822 130 41813	5110	Absorb. coil	4822 156 10641
			5111	Ferroceptor	4822 158 60514
			5112	Aerial trafo LW	4822 156 30564
			5133	Osc. coil AM	4822 157 51616
			5117,5118	Cer. res. 10.7 MHz	4822 242 70249
			5119	IF filter 450 kHz	4822 242 71197
			5120	IF coil AM 460 kHz	4822 157 51708
			5121	FM ratio det. coil	4822 157 51615
			5122	Det. coil FM 10.7	4822 153 50208
			5123	Coil	4822 157 51842
			5751	Osc. coil	4822 156 20946
TA7343P		4822 209 81245			
TEA5570		4822 209 81563			
μPC1238H		4822 209 81964			
WJM4558DD		4822 209 81054			
			Miscellaneous		
3158	4k7 Trim lin.	4822 100 10025	BU-1	Cinch plug plate	4822 267 30631
3325+3329	Slide potm. 100k	4822 105 10649	BU-2	Antenna	4822 267 20153
3365	Slide potm. 100k	4822 105 10651	BU-3-4	Push terminal	4822 209 80609
3366	Slide potm. 200k	4822 105 10652	BU-5	Headph. socket	4822 267 30558
3383,3384	Fuse res 1E	4822 111 30483	BU-6	Mains	4822 265 20262
3395	Fuse res NFR30 4E7	4822 116 52448	SK-1-7	Switch assy	4822 276 40347
3770	100k Trim lin.	4822 100 10052	SK-8	Switch assy	4822 276 40346
			SK-9	Slide SW rec 7p	4822 277 60232
			SK-10	Power switch	4822 276 11567
			1300	2.5AT	4822 253 20095

	Carbon film			Ceramic plate		*a = 2,5 V b = 4 V c = 6,3 V d = 10 V e = 16 V f = 25 V g = 40 V h = 63 V j = 100 V l = 125 V m = 150 V n = 160 V q = 200 V r = 250 V s = 300 V t = 350 V u = 400 V v = 500 V w = 630 V x = 1000 V A = 1,6 V B = 6 V C = 12 V D = 15 V E = 20 V F = 35 V G = 50 V H = 75 V I = 80 V	
	0.2 W	70°C	5%	$\Delta\Delta^*$	Tuning ≤ 120 pF NP.0		2%
					Others		-20/+80%
	Carbon film				Polyester flat foil		10%
	0.33 W	70°C	5%				
	Metal film				Metalized polyester flat film		10%
	0.33 W	70°C	5%				
	Carbon film				Polyester flat foil small size (Mylar)		10%
	0.5 W	70°C	5%				
	Carbon film				Polysterene film/foil		1%
	0.67 W	70°C	5%				
	Carbon film				Tubular ceramic		
	1.15 W	70°C	5%				
					Miniature single		
	Chip component				Subminiature tantalum	$\pm 20\%$	

© — Chips 50 V NP0 S1206			© — Chips 0,125 W S1206			© — Chips 0,125 W S1206		
1 pF	5%	4822 122 32279	6,8 E	5%	4822 111 90254	7,5 k	2%	4822 111 90276
1,5 pF	5%	4822 122 31792	7,5 E	5%	4822 111 90396	8,2 k	2%	5322 111 90118
1,8 pF	5%	4822 122 32087	8,2 E	5%	4822 111 90397	9,1 k	2%	4822 111 90373
3,3 pF	5%	4822 122 32079	9,1 E	5%	4822 111 90398	10 k	2%	4822 111 90249
3,9 pF	5%	4822 122 32081	10 E	2%	5322 111 90095	11 k	2%	4822 111 90337
4,7 pF	5%	4822 122 32082	11 E	2%	4822 111 90338	12 k	2%	4822 111 90253
8,2 pF	5%	4822 122 32083	12 E	2%	4822 111 90341	13 k	2%	4822 111 90509
10 pF	5%	4822 122 31971	13 E	2%	4822 111 90343	15 k	2%	4822 111 90196
12 pF	5%	4822 122 32139	15 E	2%	4822 111 90344	16 k	2%	4822 111 90346
18 pF	5%	4822 122 31769	16 E	2%	4822 111 90347	18 k	2%	4822 111 90238
22 pF	10%	4822 122 31837	18 E	2%	5322 111 90139	20 k	2%	4822 111 90349
27 pF	5%	4822 122 31966	20 E	2%	4822 111 90352	22 k	2%	4822 111 90251
33 pF	5%	4822 122 31756	22 E	2%	4822 111 90186	24 k	2%	4822 111 90512
39 pF	5%	4822 122 31972	24 E	2%	4822 111 90355	27 k	2%	4822 111 90542
47 pF	5%	4822 122 31772	27 E	2%	5322 111 90375	30 k	2%	4822 111 90216
56 pF	5%	4822 122 31774	30 E	2%	4822 111 90356	33 k	2%	5322 111 90267
68 pF	5%	4822 122 32267	33 E	2%	4822 111 90357	36 k	2%	4822 111 90514
82 pF	10%	4822 122 31839	36 E	2%	4822 111 90359	39 k	2%	5322 111 90108
100 pF	5%	4822 122 31765	39 E	2%	4822 111 90361	43 k	2%	4822 111 90363
120 pF	5%	4822 122 31766	43 E	2%	5322 116 90125	47 k	2%	4822 111 90543
150 pF	5%	4822 122 31767	47 E	2%	4822 111 90217	51 k	2%	5322 111 90274
180 pF	2%	4822 122 31794	51 E	2%	4822 111 90365	56 k	2%	4822 111 90573
220 pF	5%	4822 122 31965	56 E	2%	4822 111 90239	62 k	2%	5322 111 90275
270 pF	5%	4822 122 32142	62 E	2%	4822 111 90367	68 k	2%	4822 111 90202
330 pF	10%	4822 122 31642	68 E	2%	4822 111 90203	75 k	2%	4822 111 90574
390 pF	5%	4822 122 31771	75 E	2%	4822 111 90371	82 k	2%	4822 111 90575
470 pF	5%	4822 122 31727	82 E	2%	4822 111 90124	91 k	2%	5322 111 90277
560 pF	5%	4822 122 31773	91 E	2%	4822 111 90375	100 k	2%	4822 111 90214
680 pF	5%	4822 122 31775	100 E	2%	5322 111 90091	110 k	2%	5322 111 90269
820 pF	5%	4822 122 31974	110 E	2%	4822 111 90335	120 k	2%	4822 111 90568
1 nF	10%	5322 122 31647	120 E	2%	4822 111 90339	130 k	2%	4822 111 90511
1,2 nF	5%	4822 122 31807	130 E	2%	4822 111 90164	150 k	2%	5322 111 90099
1,5 nF	10%	4822 122 31781	150 E	2%	5322 111 90098	160 k	2%	5322 111 90264
2,2 nF	10%	4822 122 31644	160 E	2%	4822 111 90345	180 k	2%	4822 111 90565
2,7 nF	10%	4822 122 31783	180 E	2%	5322 111 90242	200 k	2%	4822 111 90351
3,3 nF	10%	4822 122 31969	200 E	2%	4822 111 90348	220 k	2%	4822 111 90197
3,9 nF	10%	4822 122 32566	220 E	2%	4822 111 90178	240 k	2%	4822 111 90215
4,7 nF	10%	4822 122 31784	240 E	2%	4822 111 90353	270 k	2%	4822 111 90302
5,6 nF	10%	4822 122 31916	270 E	2%	4822 111 90154	300 k	2%	5322 111 90266
6,8 nF	10%	4822 122 31976	300 E	2%	4822 111 90156	330 k	2%	4822 111 90513
10 nF	10%	4822 122 31728	330 E	2%	5322 111 90106	360 k	2%	4822 111 90515
12 nF	10%	5322 122 31648	360 E	1%	4822 111 90288	390 k	2%	4822 111 90182
15 nF	10%	4822 122 31782	360 E	2%	4822 111 90358	430 k	2%	4822 111 90168
18 nF	10%	4822 122 31759	390 E	2%	5322 111 90138	470 k	2%	4822 111 90161
22 nF	10%	4822 122 31797	430 E	2%	4822 111 90362	510 k	2%	4822 111 90364
27 nF	10%	4822 122 32541	470 E	2%	5322 111 90109	560 k	2%	4822 111 90169
33 nF	10%	4822 122 31981	510 E	2%	4822 111 90245	620 k	2%	4822 111 90213
56 nF	10%	4822 122 32183	560 E	2%	5322 111 90113	680 k	2%	4822 111 90368
100 nF	10%	4822 122 31947	620 E	2%	4822 111 90366	750 k	2%	4822 111 90369
			680 E	2%	4822 111 90162	820 k	2%	4822 111 90205
			750 E	2%	5322 111 90306	910 k	2%	4822 111 90374
			820 E	2%	4822 111 90171	1 M	2%	4822 111 90252
			910 E	2%	4822 111 90372	1,1 M	5%	4822 111 90408
			1 k	2%	5322 111 90092	1,2 M	5%	4822 111 90409
			1,1 k	2%	4822 111 90336	1,3 M	5%	4822 111 90411
			1,2 k	2%	5322 111 90096	1,5 M	5%	4822 111 90412
			1,3 k	2%	4822 111 90244	1,6 M	5%	4822 111 90413
			1,5 k	2%	4822 111 90151	1,8 M	5%	4822 111 90414
			1,6 k	2%	5322 111 90265	2 M	5%	4822 111 90415
			1,8 k	2%	5322 111 90101	2,2 M	5%	4822 111 90185
			2 k	2%	4822 111 90165	2,4 M	5%	4822 111 90416
			2,2 k	2%	4822 111 90248	2,7 M	5%	4822 111 90417
			2,4 k	2%	4822 111 90289	3 M	5%	4822 111 90418
			2,7 k	2%	4822 111 90569	3,3 M	5%	4822 111 90191
			3 k	2%	4822 111 90198	3,6 M	5%	4822 111 90419
			3,3 k	2%	4822 111 90157	3,9 M	5%	4822 111 90421
			3,6 k	2%	5322 111 90107	4,3 M	5%	4822 111 90422
			3,9 k	2%	4822 111 90571	4,7 M	5%	4822 111 90423
			4,3 k	2%	4822 111 90167	5,1 M	5%	4822 111 90424
			4,7 k	2%	5322 111 90111	5,6 M	5%	4822 111 90425
			5,1 k	2%	5322 111 90268	6,2 M	5%	4822 111 90426
			5,6 k	2%	4822 111 90572	6,8 M	5%	4822 111 90235
			6,2 k	2%	4822 111 90545	7,5 M	5%	4822 111 90427
			6,8 k	2%	4822 111 90544	8,2 M	5%	4822 111 90237
						9,1 M	5%	4822 111 90428
© — Chips 0,125 W S1206								
0 E	jumper	4822 111 90163						
1 E	5%	4822 111 90184						
1,1 E	5%	4822 111 90377						
1,2 E	5%	4822 111 90378						
1,3 E	5%	4822 111 90379						
1,5 E	5%	4822 111 90381						
1,6 E	5%	4822 111 90382						
1,8 E	5%	4822 111 90383						
2 E	5%	4822 111 90384						
2,2 E	5%	5322 111 90104						
2,4 E	5%	4822 111 90385						
2,7 E	5%	4822 111 90386						
3 E	5%	4822 111 90387						
3,3 E	5%	4822 111 90338						
3,6 E	5%	4822 111 90389						
3,9 E	5%	4822 111 90391						
4,3 E	5%	4822 111 90392						
4,7 E	5%	5322 111 90376						
5,1 E	5%	4822 111 90393						
5,6 E	5%	4822 111 90394						
6,2 E	5%	4822 111 90395						